

THE RADIO EXPERIMENTER'S MAGAZINE

HUGO GERNSBACK

Hugo Gernsback
Editor

SHORT WAVE CRAFT

July

WORLD'S
LARGEST
SHORT WAVE
CIRCULATION

Series Good
"His New Love"

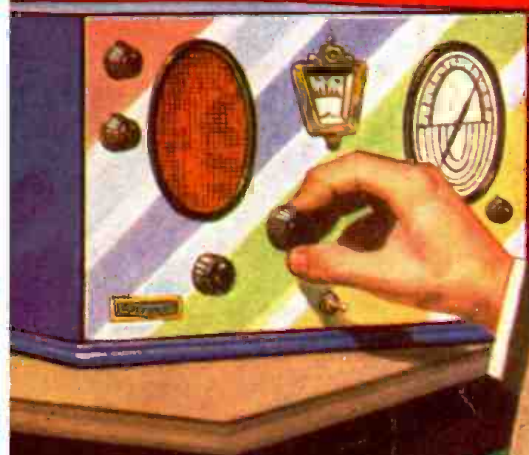

25¢
IN CANADA
30¢

Here's the new - Big

1935 OFFICIAL SHORT WAVE RADIO MANUAL



When we brought out our 1934 OFFICIAL SHORT WAVE RADIO MANUAL, of which many thousands of copies were bought by short wave enthusiasts, we promised you that a new volume would be published every year.

In keeping with this promise, we now take great pleasure in announcing the 1935 OFFICIAL SHORT WAVE RADIO MANUAL. There has been tremendous progress and a great boom in short waves in the past year, and the art has made such rapid progress that no single book, up to now, has been able to keep up with this progress. The 1935 OFFICIAL SHORT WAVE RADIO MANUAL fills this need, and it fills it completely. All the progress made in short waves, whether it is in set building, whether it is in radio servicing, whether it is in new models, whether it is in new short wave discoveries, all are faithfully reported and chronicled in this great 1935 volume.

Like its predecessor, it is a BIG book, in which you will find literally EVERYTHING in short waves—nothing has been left out. Not only is it a complete manual, but it is a great encyclopedia of short wave facts, information, hookups, photographs, tables, maps, etc., etc. The wealth of material is so great that it would take several pages to list all the valuable data that has been included in this volume.

Similar to last year's volume, the new book has been edited by Hugo Gernsback, Editor of SHORT WAVE CRAFT and H. W. Secor, Managing Editor, and if you are and have been a reader of SHORT WAVE CRAFT, and particularly if you have seen the 1934 Manual, you will know just what you can expect from this, the greatest short wave manual ever put out by Mr. Gernsback. Here are the star features of the book:

29 ★ Features:

- ★ 1—Short Wave Beginners' Section—Dozens of new simplified circuits for 1-2 and 3 tube receivers, including famous "Doerle" and "Oscillodyne", etc.
- ★ 2—Short Wave Receivers—All types discussed only which have "good the test" of actual operating service. Full details for constructing them, etc. "Band-Spreading"; the Doerle, 5-tube T.R.F. Receivers, etc.
- ★ 3—Battery Short-Wave Receivers—1-2, & 3 tube heterodyne, designed especially for battery operation.
- ★ 4—"5 Meter" Department—All the latest "Wave" including latest transmitters, "Long Line" oscillators, improved "high sensitivity" receivers. How to arrange best aerial to get greatest distance, 5-meter transmitters, hook-ups, etc.
- ★ 5—Short-Wave "Artificial Feeder" Apparatus—also newest therapeutic and other allied applications of ultra short waves.
- ★ 6—Short-Wave Experimenters' Section—filled with Short-Wave Kinks, Short-cuts, etc., of interest to every experimenter.
- ★ 7—Ultra Short Waves—Newest circuits, apparatus, and results obtained in this field.
- ★ 8—Commercial "Short Waves" and "All-Wave" Haves Full Sourcing Data for "Set-Owners" and "Service-men."
- ★ 9—How to build "Power Supply" Units for Short-Wave Receivers.
- ★ 10—Latest Short-Wave Converters—With servicing data on Commercial Models.
- ★ 11—The Short-Wave Antenna—Including latest "Noise-Reduction" type, "Transposed Lead-In" systems, shielded cable, Double-Doublnet, etc.
- ★ 12—Short-Wave Superheterodynes—From 3 to 11 tubes—latest descriptions and diagrams including commercial all-wave superhets.
- ★ 13—Phone Transmitters for Amateur Stations—How to build them.
- ★ 14—"Skip" Distance—Heaviside layer, etc.—explained; physics of Short Waves.
- ★ 15—Super-Regenerative Short-Wave Receivers—latest circuits, etc.
- ★ 16—Recording "Foreign" and "Domestic" Short-Wave programs. All systems in use.
- ★ 17—"High Fidelity"—How to obtain it in Short-Wave Receivers.
- ★ 18—The best Short-Wave Questions and answers of the year.
- ★ 19—The best Short-Wave "Kinks" of the year.
- ★ 20—Foreign Short-Wave Review—Novel circuits, apparatus, etc.
- ★ 21—Tubes for Short-Wave purposes—including tables of latest tubes for Short-Wave transmitters and Receivers.
- ★ 22—Short-Wave Transmitters—All about the new "Long Lines" Oscillators as well as other "simplified" high-efficiency transmitters, Rack and Panel jobs, Crystal Control, etc.
- ★ 23—Multi-Purpose Tubes—How to use them on Short Waves—Sets in which 2 tubes=4; 3 tubes=6; etc.
- ★ 24—"Audio Amplifiers" for Short-Wave Receivers, Circuits, etc.
- ★ 25—"Band-Spread"—How to spread the stations over the dial for easier tuning.
- ★ 26—Plug-less "Mono-Coil" Receivers—How to build efficient switch-type coils to eliminate plug-in coils; "Clip-Coil" Receivers, etc.
- ★ 27—Boosters, Pre-amplifiers, and Beat Oscillators—How they work, with constructional data, diagrams, etc.
- ★ 28—Portable Short-Wave Receivers and Transmitters—Transmitter Power supply from Ford Coils, etc.
- ★ 29—Every short-wave diagram, every short-wave set, EVERYTHING in other words that has been manufactured in the commercial set line, will be found in this special enlarged section. Hundreds of valuable diagrams, with tube layouts, resistor values, color codes of wiring cables, etc., and in every case, each tube in each set clearly indicated on the diagram, wherever this information can possibly be obtained.

CLIP AND MAIL THIS MONEY SAVING COUPON TODAY

SHORT WAVE CRAFT
90 Hudson Street,
New York, N. Y.

Gentlemen: I enclose herewith my remittance of \$2.00 for which please send me one copy of the 1935 OFFICIAL SHORT WAVE RADIO MANUAL. I understand that the price of this book before publication, the price is \$2.50. If you prefer, I will pay by check or money order. Please return my remittance letter if it contains cash or currency.

Name State

Address

City

SPECIAL PRE-PUBLICATION OFFER

As has been customary with us in the past, we give our readers the opportunity to order the book before it comes off press and save money. The price of the new 1935 OFFICIAL SHORT WAVE RADIO MANUAL will be \$2.50 as soon as it comes off the press. No reduction in price will be made later. To you, who order this book before publication, the price is \$2.00. As soon as the OFFICIAL SHORT WAVE RADIO MANUAL is published, the pre-publication price will be immediately withdrawn. It is, therefore, to your advantage to order your copy today.

OVER 240 BIG PAGES • OVER 1000 Illustrations
Size 9 x 12 Inches — Flexible Looseleaf Leatherette Binder

Short Waves in Europe



Photo at left shows a new portable short-wave transmitter of German design used for reporting "spot news."

Photo at right shows two of the antenna towers at the Danish short-wave transmitting station, OXY.

Below—Special short-wave research laboratories operated at the Danish short-wave station, OXY.

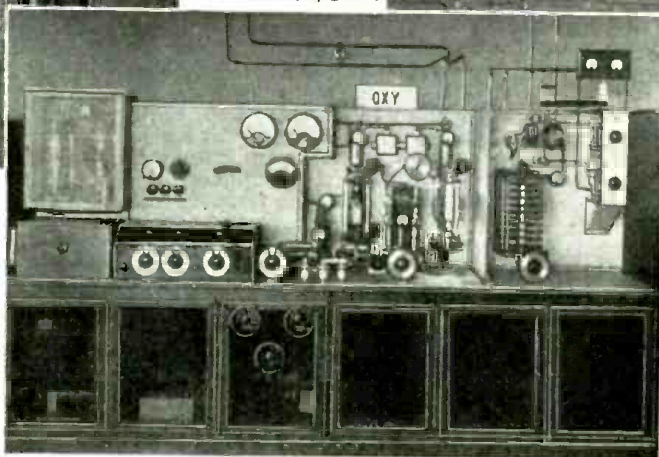
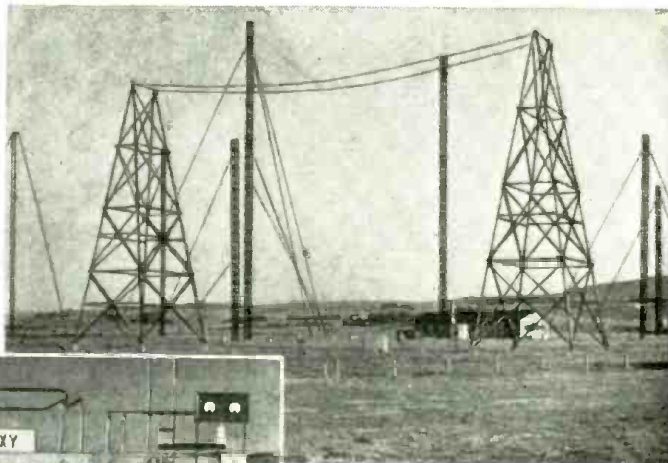

● THE photo at the upper left-hand corner of this group shows one of the newest German portable short-wave transmitters. It was devised by the engineers of the famous Telefunken Co. and is intended for use by radio reporters. The reporter is here shown speaking into the mi-

crophone, which is attached by a long flexible cable to the transmitter carried on the back. These transmitters are not new, of course, to the American broadcasting companies, and have been used many times in the past five years. They have even been strapped on the back of a man descending from a plane in a parachute. The range of such transmitters is from 1 to 3 miles usually.

The other two photos show the (Continued on page 191)

Short Waves Work Typewriter 10,000 Miles

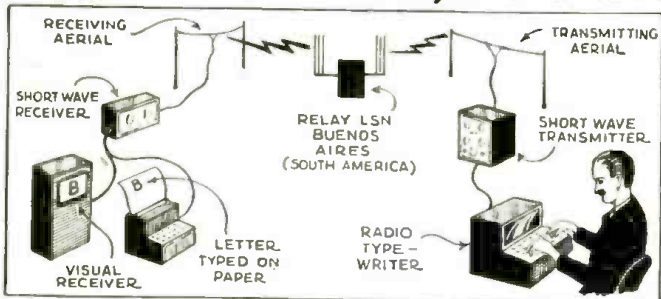

The diagram and photos herewith show a very remarkable radio typewriter demonstration carried on between New York and "Little America," before the departure of Admiral Byrd. The black box shown in the picture with the three men was a visual detector.



The photos above show the presentation of the Radiotype radio-operated typewriter to Admiral Byrd by T. J. Watson.

● RADIO listeners, particularly those with powerful regenerative receivers, may have been slightly puzzled a short time ago when the steady stream of traffic from KFZ, the transmitter at the winter camp of Admiral Richard E. Byrd in Little America, was characterized by a peculiar "clicking" modulated signal. Upon tuning this signal the listener found it to be made up of sharp impulses which seemed to have no direct connection with a coded group nor to be in any code at all.

Unknowingly these listeners were hearing the first long-distance tests of a high-speed replica printer which is known as the Radiotype. A group of engineers, under the direction of Walter S. Lemmon, General Manager of the Radiotype Division of the International Business Machines Corporation, has recently announced that these tests between Little America and the United States were entirely successful from an experimental standpoint.

Admiral Byrd, as operator of the Radiotype keying device at Little America, sat before the keyboard of an electric typewriter. As he typed the message, an impulse was impressed upon the carrier wave of KFZ, the message was picked up and relayed by LSN in Buenos Aires, Argentina,



Visual indicator used a neon tube whereby the letters were made visible to the eye as they arrived.

picked up by a receiving set located in the hills back of Ridgewood, N. J., and then relayed again over a 5-meter link to the laboratory in Ridgewood where a receiving unit was installed. At each impulse, sufficient power was available to actuate one of the keys of the receiving typewriter.

The signal, in addition to pulling down the key of a typewriter, actuated another device (Continued on page 191)

2-Channel Picks Up Two

By Art Gregor



Listening to our favorite short-wave program while—

● THE Dual Channel receiver described in this article is something quite different from the usual run of radio receivers. This set is the most versatile of any set that we have ever operated. It can be used as two separate receivers on any two different frequencies simultaneously, short or long wave. This set was built for the express purpose of serving as a vacation radio, not so much as a portable, but so that the OW (wife) could listen to her favorite broadcast program or play, and at the same time the OM (old man) could listen to the short-wave stations or in any of the popular Ham bands. Needless to say the peace and comfort of the vacation trip can be looked upon as resembling a second honeymoon—Hi!—What—after twenty years of bliss? Well anyway, you probably understand by this time that this set is a compromise of the desires of both parties concerned. And, besides the above-mentioned facts this set has many practical uses.

Dual Purpose Tubes Used

Twin triodes serve to make two receivers in this case with only three tubes. One set is a 2-tube affair and the other is a 3-tube set which will work a loudspeaker. In other words "three tubes equal five."

In the first 19 the two sections or triodes are used as a regenerative detector and one stage of audio. The second 19 is used in the same manner; one section serving as the detector and the other stage as driver for the 33 pentode,

which works the loudspeaker in very good fashion. It was decided to use plug-in coil in both of the detectors so that two separate short-wave stations could be tuned in at the same time, that is when the OW didn't want to hear her favorite radio star. We had the pleasure of listening to the airplane-to-ground conversations and without retuning the receiver, both sides of the conversation were heard. The ship-to-shore telephone circuit also provides much entertainment for those who like to know much about other peoples' business. When listening to the Amateurs talk to each other we have always had to retune the receiver in order to hear the answers to the requests for reports as to the quality and strength of their station but not so with this "rig." So much for the thrills we received with this set—now for the constructional suggestions.

Construction Hints

We really have two separate receivers in one in this set, one consists of a regenerative detector and a single stage of

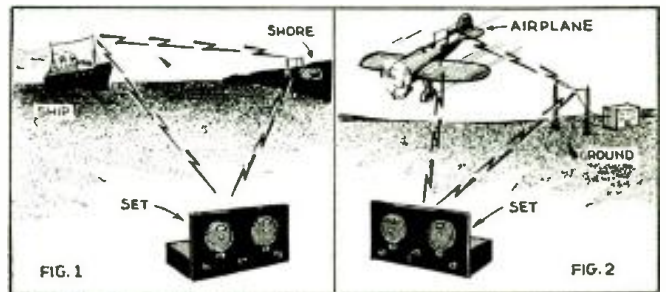

Some of the thrills experienced in operating this novel receiver.

resistance-capacity coupled audio amplification, while the other set has two stages of audio. The output stage uses a pentode and will give full speaker volume on all stations in the regular broadcast band, and those short-wave stations

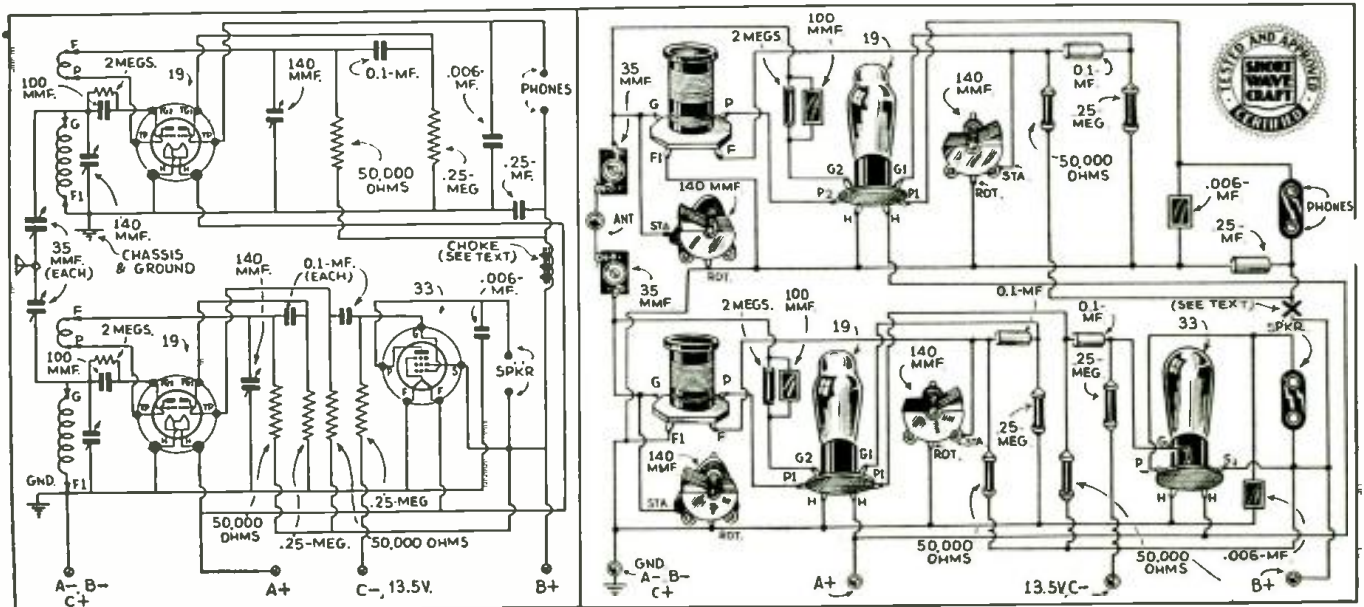

Schematic and physical diagrams of the 2-channel receiver.

S-W Receiver

Programs at Once



Here is a very unique combination of two receivers. One section uses 3 tubes and operates a loudspeaker, while the other is a 2-tube set intended for headphone operation. It has been designed so that broadcast stations could be received simultaneously at full loud-speaker volume, without interfering in the least with short-wave reception.

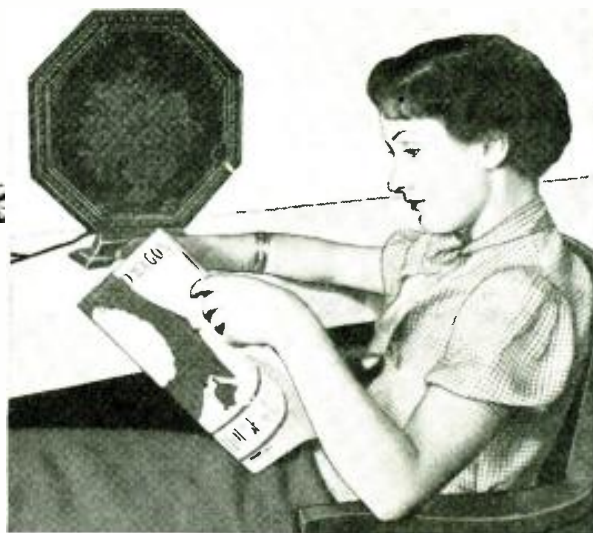

—a member of the fair sex listens to a regular broadcast program.

which are in the high-power group. The artist's drawings show the various uses for this set and probably the most useful of all is shown by the photos at the head of the story.

Each section of the receiver is constructed exactly the same. Regeneration is controlled with usual *throttle*

exactly. Avoid running wires parallel and close together.

The use of a common plate supply at first presented a difficulty which was not in the least encouraging. When the 3-tube set was tuned in to a broadcast station, the same station could be heard in the earphones of the 2-tube set. Many methods of eliminating this difficulty were tried and the only way it could be overcome was by the use of the large choke in the plate supply of one of the sets. This choke is

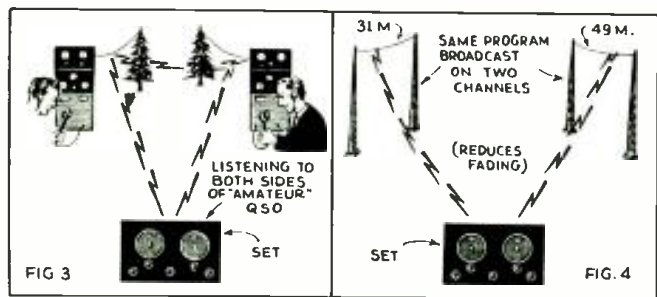

Other novel uses for "duplex" reception are illustrated above.

(variable) condensers and the grid circuits are tuned with 140 mmf. condensers. A common antenna can be used for both sets and not the slightest sign of interference is encountered if the reader follows the diagram and layout

First Time! New!
This Set Actually Receives 2 Stations on Different Wavelengths at the Same Time!

the primary of a push-pull output transformer, designed to work with a pair of 45's in push-pull. The 1/4 mf. by-pass condenser connected from the battery side of the choke is necessary, if the quality of reception is not to be spoiled. This choke can be any good high inductance affair so long as
(Continued on page 165)

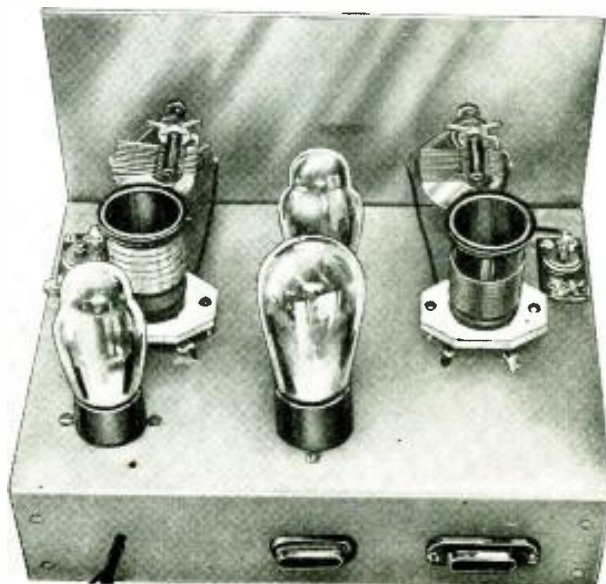
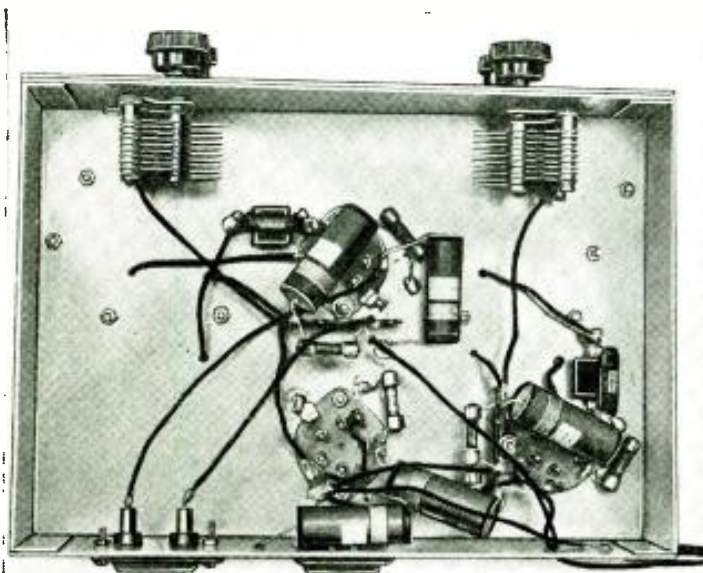

Underneath and backviews, showing the placement of parts in the new Dual Channel receiver.



Beginner's

ALL-ELECTRIC

By

George W. Stuart, W2AMN



Checking the performance of this beginner's all-electric receiver. Foreign stations are heard with comfortable speaker volume.

● FOR those who wish to try their hand at building an all-electric short-wave receiver, we describe this set and endeavor to give hints which will aid the reader in overcoming the usual difficulties encountered in the construction of 110 volt A.C. sets.

This receiver is built in two sections and allows the reader to choose either section or both. One section is the R.F. and audio unit and the other is the power supply. The two are fastened together by a 5-prong plug. This plug is mounted on the tuner and fits into a 5-prong socket which is mounted on the power supply. This permits the power supply unit to be removed from the set and used in conjunction with any other receiver. This was done because we see no reason why the experimenter should build the power supply only for this set and then be forced to build another for other purposes. While this set uses 6.3 volt tubes, a transformer with two windings for heaters having either 6.3 or 2.5 volt requirements can be used. The connections shown in the diagram for the 5-prong plug and socket can be changed to use a 6-prong arrangement if the builder wishes to isolate the windings one from the other.

The R.F. and Audio Unit

The tubes used in this receiver were chosen in order to allow the use of the 6F7 with its R.F. pentode and triode characteristics. This tube, having a 6.3 volt heater, required the use of other tubes with similar heaters.

The 6F7 functions as an untuned

R.F. amplifier and a regenerative detector. The untuned R.F. pentode section isolates the antenna, to a satisfactory degree, from the triode detector and thus allows smooth control of regeneration and the elimination of dead-spots caused by the antenna. Inductive coupling is used between the R.F. stage and the detector for a further degree of stability and gain. To

This is a dandy all-electric short-wave receiver for the beginner and S-W fan, who wishes to combine simplicity and economy in his first 110 Volt A.C. set. This set is designed so that the power supply can be detached and used with another type of receiver or for other experimental work. A dual purpose tube is used in the R.F. section, and in this manner an untuned R.F. stage, a detector and two stages of audio amplification are obtained with three tubes. The majority of foreign S-W broadcast stations are brought in with comfortable loudspeaker volume with this 4-tube all-electric receiver.

the triode detector is coupled a 37 resistance-capacity coupled audio amplifier; this serves as a booster for the 41 pentode output stage and gives good speaker volume on the majority of the short-wave stations.

Regeneration in the detector is controlled by varying the plate voltage of the detector and works surprisingly smooth and has very little effect so far as detuning the grid circuit is concerned; in fact it is so smooth that it is difficult to know when the tube goes into oscillation.

The connections of the 6F7 are the most important part of the set. The biasing resistor for the pentode section of the tube is connected in the cathode circuit. The grid-leak of the triode section should be connected directly from the grid to the cathode and not to the "B" negative side of the resistor. This biasing resistor should be by-

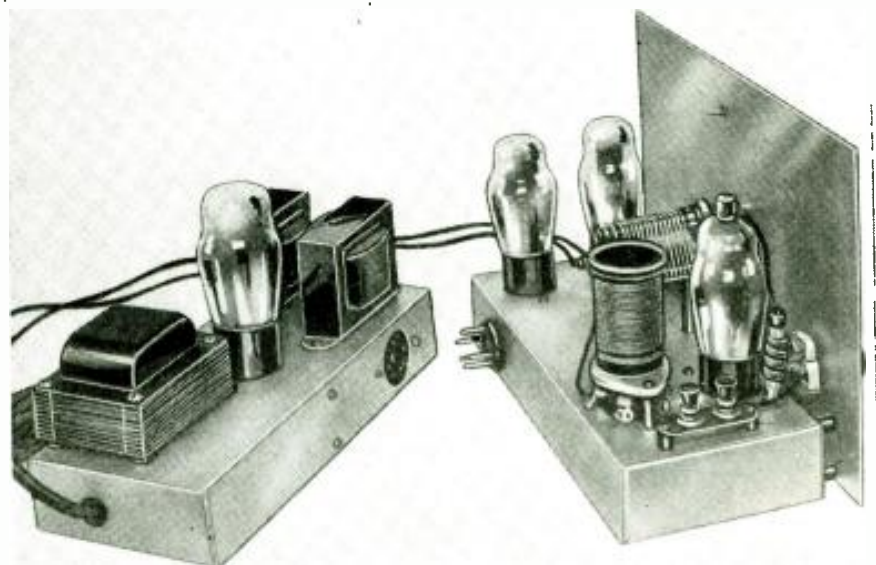

General view, showing how the two units are plugged together, making a very simple complete receiver. This set should appeal to every short-wave Beginner, as its construction has been planned to be as simple as possible.

S-W Receiver

passed with a fairly large condenser in order to eliminate instability in the detector circuit.

The grid circuit of the R.F. stage is untuned and an R.F. choke of around 2.5 mh. inductance is used. This method seems to work about the best and provides maximum sensitivity. The antenna is coupled through a 50 mmf. variable condenser and should be adjusted to give best results with the particular antenna used. If you are unfortunate enough to live very near a powerful broadcasting station, then you will need a wave-trap in the antenna lead in order to eliminate the interference. This should consist of about 60 turns of No. 28 wire, wound on a 2-inch form and tuned with a .00035 mf. variable condenser, to the frequency of the interfering station. The audio amplifier is conventional and the only warning we have to offer is—don't forget the .006 mf. plate by-pass condenser in the plate circuit of the 41 tube.

The Power Supply

The power supply is one of the most important parts of any short-wave receiver. The main requirements are: low hum level, which necessitates plenty of filtering, and freedom of tunable hums. Tunable hums are undoubtedly the most difficult to get rid of. If we refer to the diagram, we see that small

by-pass condensers have been used in the high voltage winding. These go a long way toward eliminating tunable hums and should by no means be left out, if a first-class job is to be the result. The power transformer used in the power supply depends upon whether it is to be used as a general purpose supply or whether it is only to be used with this set. It is advisable from the economic standpoint to use a fairly large transformer, one capable of supplying at least 6 or 7 tubes, so that it will serve for other receivers which the true experimenter is sure to build. And, as hinted before, the transformer should have two filament windings, one 6.3 volt and one 2.5 volts, so that it can be used on other sets of different designs. The filter chokes should likewise be selected with the thought in mind that the power supply is to be used in conjunction with other receivers. We suggest that they have a rating of 100 milliamperes and an inductance of 30 henries. Electrolytic filter condensers are used in this power supply and have a rating of 500 volts, with a capacity of 8 microfarads. This allows a good safety factor with a power transformer having 250 volts each side of center tap in the high voltage secondary.

The bleeder resistor can have taps to provide various voltages if the power
(Continued on page 176)

Parts List— Beginners All-Electric

- 1—50 mmf. antenna trimmer (apc 50 Hammarlund)
- 1—.00015 (or .00014) mf. tuning condenser, National
- 4—.1 mf. by-pass condensers (Sprague)
- 1—10 mf. by-pass condensers (Sprague)
- 2—.1 mf. by-pass condenser, Sprague
- 1—.25 mf. by-pass condenser, Sprague
- 1—.006 mf. by-pass condenser, Sprague (600 volt)
- 1—.0005 mf. mica condenser, Aerovox
- 1—.0001 mf. mica condenser Aerovox
- 1—2 mek. 1/2-watt resistor, I.R.C.
- 1—500-ohm 1/2-watt resistor, I.R.C.
- 2—100,000-ohm 1/2-watt resistor I.R.C.
- 2—1/4 meg-ohm 1/2-watt resistor I.R.C.
- 1—50,000-ohm 1/2-watt resistor I.R.C.
- 1—50,000-ohm 1-watt resistor I.R.C.
- 1—2,000-ohm 1-watt resistor I.R.C.
- 1—500-ohm 1-watt resistor I.R.C.
- 1—50,000-ohm Potentiometer (Electrad)
- 2—2.1 mh. R.F. choke (Hammarlund)
- 1—set 6-prong, 3 winding plug-in coils, Na-Ald. (Hammarlund)
- 1—7-prong ceramic socket, Bud
- 1—6-prong ceramic socket, Bud
- 1—6-prong wafer socket Na-Ald.
- 1—5-prong wafer socket Na-Ald.
- 1—1"x9"x1 1/2" aluminum chassis, Blan
- 1—7"x10" aluminum panel, Blan
- 1—Antenna-ground terminal strip, Na-Ald
- 1—Type "B" National dial
- 1—5-prong panel-mounting power plug, Na-Ald.
- 1—6F7 RCA Radiotron
- 1—37 RCA Radiotron
- 1—41 RCA Radiotron
- POWER SUPPLY PARTS LIST**
- 1—4"x9"x1 1/2" chassis, Blan
- 1—Power transformer (see text) Kenyon
- 2—30 H. 100 milliamper filter chokes, Kenyon
- 1—8-8 mf. dual Electrolytic condenser, Sprague
- 1—8 mf. Electrolytic condenser, Sprague
- 1—15,000-ohm, 35-watt, voltage divider, Electrad
- 1—4-prong wafer socket, Na-Ald.
- 1—5-prong wafer socket, Na-Ald.
- 2—.002 mf. high-voltage by-pass condensers, Sprague
- 1—80-RCA Radiotron

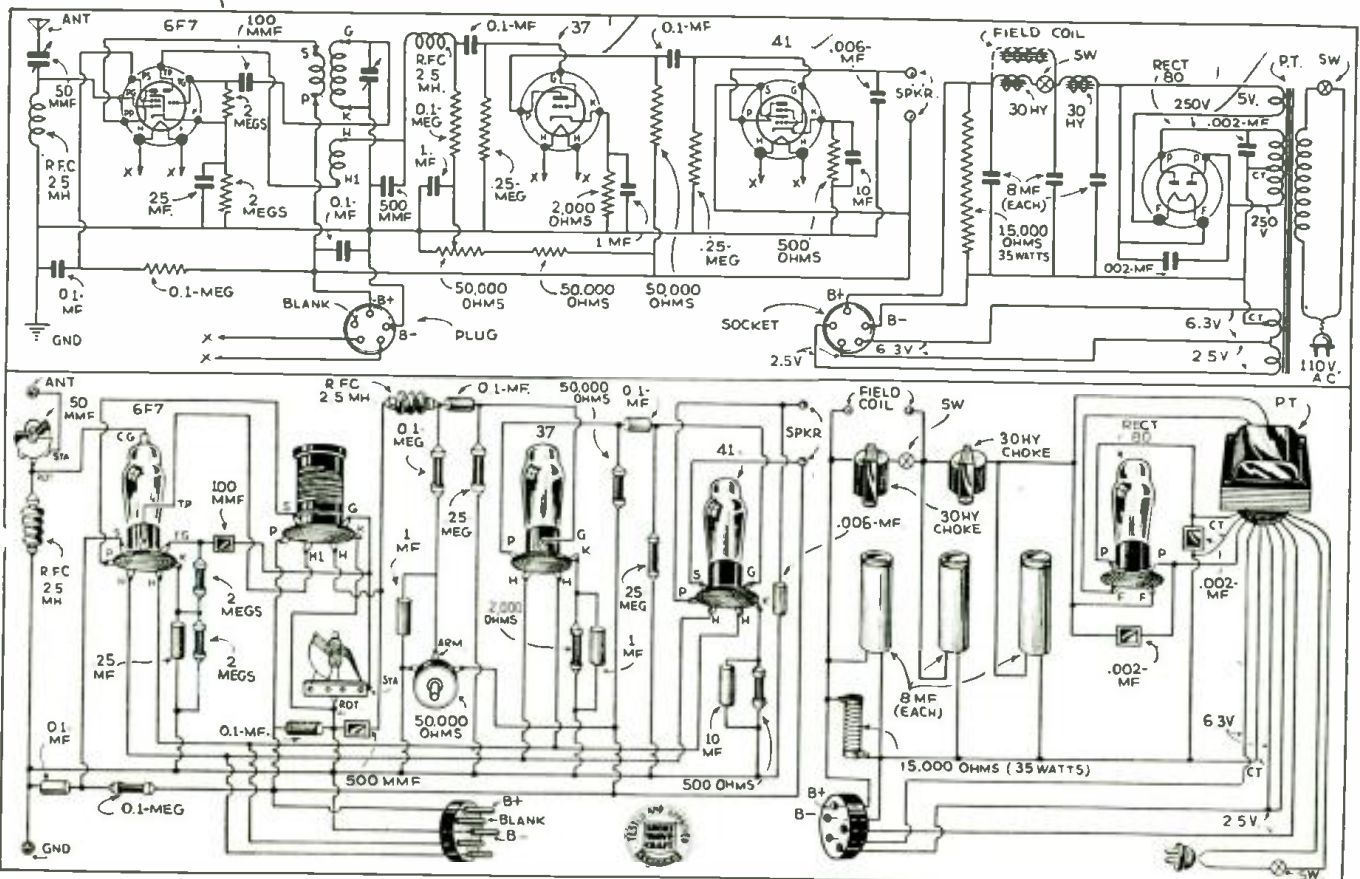

Schematic and physical diagrams for the beginner's receiver. Note that the power supply will deliver 6.3 volts when used with this receiver, or 2.5 volts when used for other purposes.

The "SWITCH COIL 2"

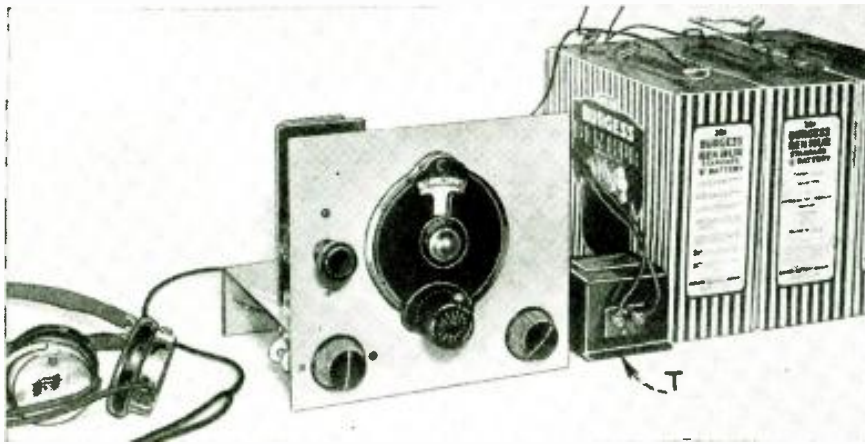

The "Switch Coil 2" receiver, covering 15 to 100 meters by simply turning the hand switch at the left center of the panel, is here shown hooked up with "B" batteries and phones—all ready to go places! "T" indicates the heater transformer or "A" battery may be used.

● BECOMING tired of forever changing plug-in coils, the writer decided to build a set using a good low-loss switch with all the coils mounted in the set. With a low-loss switch and coils of small diameter, the loss is nil and the bands can be changed in a flash with just a twist of the wrist. No tugging at stubborn coil forms, pulling the set all over the table to get the coils out, and then relocating the coil prong holes in the sockets! The set uses a 6C6 in an electron-coupled detector circuit, renowned for its sensitivity and stability and justly deserving of its great popularity. A 37 tube takes care of the audio output to the phones, with excellent volume, although not enough for a loudspeaker. A 7 by 8 inch panel is used with a 6 by 8 inch

sub-base. The panel is held to the base by the volume control and the antenna condenser.

The set is tuned with a 140 mmf. midjet condenser on the front panel. The coil switch and the 35mmf. antenna condenser are each mounted on a piece of bakelite bolted to the panel. The switch has its rotor isolated from the panel to reduce the capacity between the contacts. Although this is already low, there is no harm in reducing it still further. The antenna condenser naturally has to be insulated from the panel as the antenna current flows on both stator and rotor.

The three coils are mounted on a piece of bakelite 2½ by 4¾ inches, one above the other, with their axes parallel. This is satisfactory as the coils are

spaced slightly more than half their diameters, which is a little more than the satisfactory minimum necessary, as the other coils may be considered as pieces of metal in the field of the one in use. The two coils not in use are left *floating*, as is the switch rotor. No resonance effects from the unused coils were encountered. The coils are wound with double-silk covered wire on 1-inch diameter bakelite tubing, 1½ inches long per piece. The forms are bolted to the coil panel, the leads running through holes in the panel to the switch. Coil turns and wire sizes given in the list of parts. The tap is taken off by doubling the wire back on itself and twisting it up, the twist ending where the tap on the coil is to be. The volume control is a 50,000-ohm affair most suitable for adjusting screen-grid circuits.

Isolantite sockets are used, two for the tubes, one for the battery plug, and one for a plug-in coil, if one should ever want to use plug-in coils. This socket can be connected across the unused set of contacts on the switch, although this has not been done in this set. Sometime perhaps one may wish to hear a special program on the broadcast band when the regular broadcast set is in use. Instead of unprofitable argument, all that is necessary is to insert the broadcast coil, put on the phones and flip the coil switch to hear the desired program.

The output of the detector is fed through one of the new Hammarlund R.F. (radio frequency) chokes by-passed by two .0005 mf. condensers to the resistance-coupled 37 stage. The by-pass for the cathode resistor of the 37 and the screen and suppressor of the 6C6 are half-mike (.5 mf.) paper dielectric condensers.

Remember also to test the parts be-

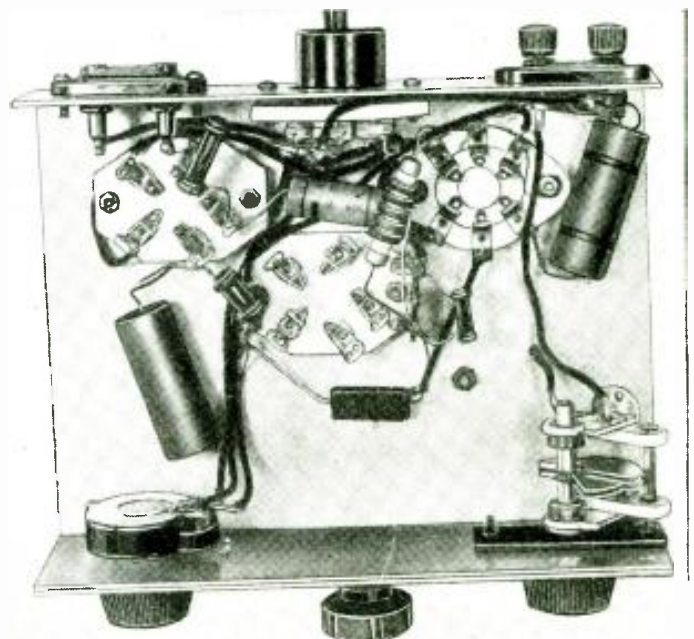
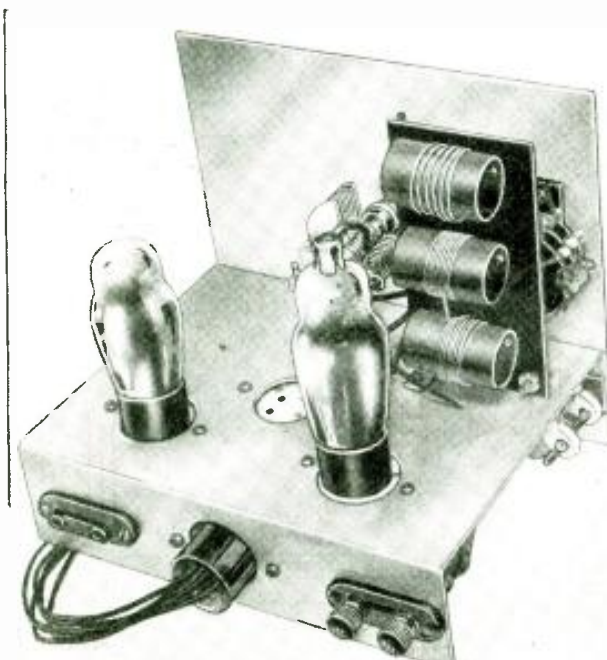

Rear and bottom views of the "Switch Coil 2" receiver, the cost of which is very low; furthermore it can be assembled and built in one evening by the average radio experimenter.

Covers 15 to 100 Meters

fore putting and wiring them in place. It might be a long shot that something will be defective, but in the long run time will be saved and one can be sure everything is up to par. If one doesn't check the parts and a leaky condenser is wired in the set, it will probably work, but very poorly and the leaky condenser is liable to go unsuspected and the set considered a "flop" with time and money wasted. The highest quality parts should be used, as the best is generally the cheapest in the long run and costs but little more. One can then feel fairly certain too that the most is being gotten out of the circuit.

Careful soldering with no cold joints also brings up the performance level to heights necessary for the A1 reception of foreign stations. Be extremely careful when soldering the coil leads to the switch and use a minimum of solder and an absolute minimum of flux. Solder spilled in the switch is liable to cause a disagreeable short and still more of a headache when it has to be taken out after molding itself into corners and around things. The same applies to resin, only to a greater degree, as it is almost impossible to get out after it has flowed in and it makes things real noisy. Also, one has to wait quite a while for it to wear out with switch motion, as the switch is a small one and there is not a great amount of pressure between the contacts, which are necessarily small to eliminate capacity effects.

If all connections are correctly made the set should work at the first try. Plug in a pair of good tubes that have

This Month's \$20.00 Prize Winner By ERNEST KAHLERT



You can tune in any wavelength from 15 to 100 meters on this "Switch Coil 2" receiver. It is a very good set for the short-wave fan and does away with all plug-in coils on the popular short-wave broadcast bands. The regeneration control is very smooth, as tests have demonstrated. This set, if used with batteries, requires 6C6 and type 37 tubes; for 110-volt A.C. operation you can use a 57 and a 56. The plate supply may be from batteries or a good B-eliminator.

been recently tested O.K., push the phone tips into the jack at the back, hook up the antenna and plug in the batteries and you're all set "to go places." No receiver can do well on a poor antenna, not even the largest of them. The RCA trans-Atlantic receiving station makes use of several miles of antenna, on a 15-tube super no less, and one can depend on it that the antenna carries a large part of the burden in reception. With this receiver a straight wire, some 75 feet long will work nicely. Or, several wires of different lengths and pointing in different directions may be tried. The antenna condenser on the panel is very helpful

as with resonant antennas frequent adjustment is necessary. The old bugaboo of *dead-spots* may be helpful, because when one is encountered you can tell that the antenna is tuned to that frequency and there is real power transfer. The set was tried out with a 6-volt storage battery, imparting that rosy glow to the filaments, and with 90 to 135 volts of "B" battery hopping through the phones. One hundred eighty volts from a "B"-eliminator was harnessed up, but gave a slight hum, hardly noticeable but not to be compared with the silent batteries. There was only a very slight increase in signal strength
(Continued on page 179)

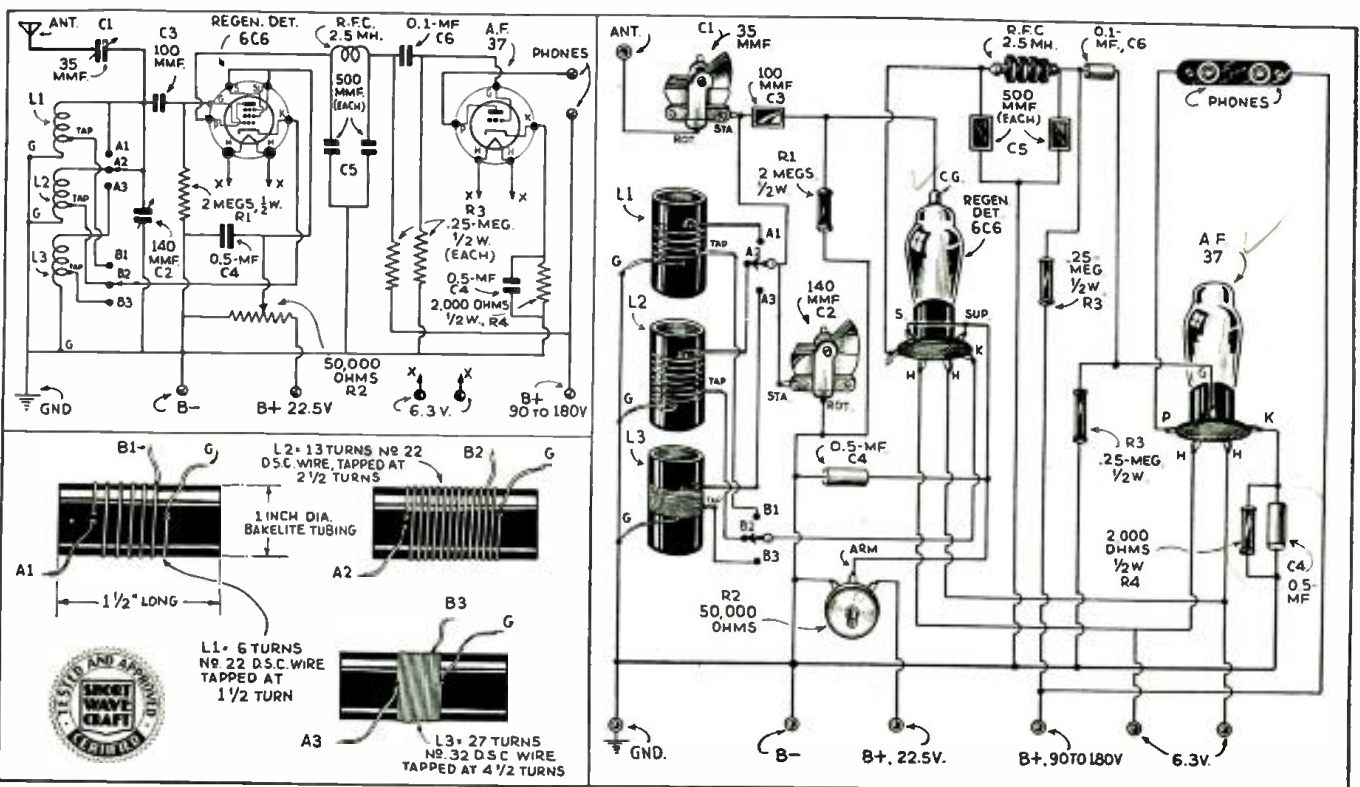

Complete wiring diagrams both in picture form and schematic are given above for the "Switch Coil 2." The wiring is really very simple and can be easily followed from the above diagrams.

The ABC OF AUTOMATIC VOLUME CONTROL

By Clifford E. Denton

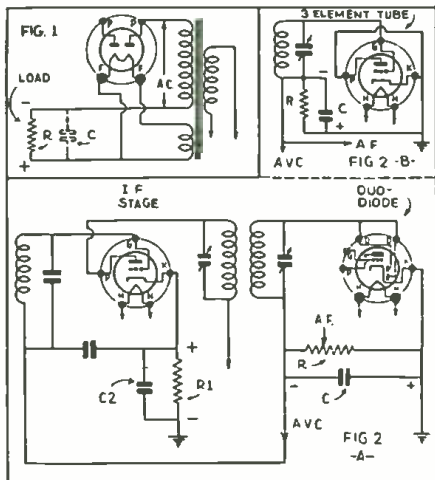

The diagrams above serve to show the basic action taking place in A.V.C. circuits.

● SO much interest has been evidenced by short-wave set-builders in automatic volume control (A.V.C.) circuits that it is felt that the following information will be doubly welcome. In its essentials A.V.C. serves to maintain a constant audio frequency signal level in the loud-speaker or phones. However, the statement just made should be altered due to the fact that the use of A.V.C. will not guarantee a constant loudspeaker signal level, unless the conventional A.V.C. circuits are supplemented by some form of audio automatic volume control.

Fundamentals

The speaker volume level (even though A.V.C. is used) will depend on the percentage of modulation of the transmitter and the characteristics of the modulator or detector circuits. Take a standard B.C. (broadcast) receiver equipped with A.V.C. and note the change in speaker volume level, with the increase or decrease in the percentage of modulation of different transmitters. Very little has been done with audio frequency A.V.C. circuits to date, although this important factor will receive considerable attention in the near future.

Not being interested in *quality* as much as *quantity* and *constancy* of signal level, it is at once apparent that A.V.C. circuits prove worth while in short-wave phone reception, inasmuch as they serve to maintain a constant radio frequency signal level at the second detector or de-modulator tube, even though the *actual* signal level at the antenna varies over a fairly wide range.

Thus, for good short-wave reception we are not trying to maintain a constant audio-frequency signal level in the speaker, as much as a constant radio frequency signal level into the de-modulator or detector circuit. This effect is accomplished within the receiver itself and the efficiency of operation depends upon the proper selection of the

Part one herewith of Mr. Denton's article covers the long-sought basic information on A.V.C. which many readers have asked for. In this article the fundamental action of A.V.C. is discussed in a lucid manner; also how you can apply A.V.C. to your short-wave receiver.

various components, tubes, types of circuits, etc., which are discussed further on.

Simple Circuit Action

In actual practice some portion or all of the radio frequency signal is rectified and the resultant D.C. voltage developed is used to control the sensi-

tivity of the receiver. This is accomplished by using a circuit similar to that of Fig. 1. This figure illustrates a very common form of rectifier circuit where the conventional 60-cycle current is rectified and appears as a pulsating direct current in the output. The load resistor R is shunted by the condenser C, which tends to smooth out the peaks and supply energy during the time periods when current is not flowing in the rectifier circuit. This rectifier creates a potential having a definite polarity and provides an electric current essentially D.C. in character, but having a small value of ripple imposed upon it. Note that the filament of the rectifier tube is considered the most positive point in the circuit. Remember this—it will be valuable in analyzing circuits of this type wherever encountered.

A more practical circuit showing the application of rectifiers for the production of A.V.C. voltages is shown in Fig. 2A and 2B. Here the diode portion of a duo-diode tube and a triode tube are used as rectifiers. During that period of time when the diode plates or the grid as the case may be are positive in potential, current will flow in the load resistor R. The condenser C serves as a radio frequency by-pass across R and also serves in much the same manner as condenser C in Fig. 1.

Any current (Continued on page 168)

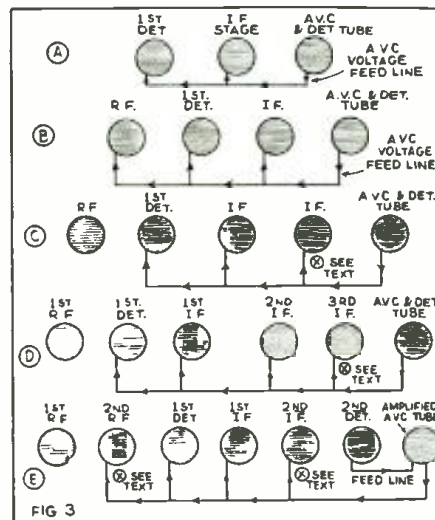

This diagram shows the tubes to be controlled by A.V.C. in different types of super-het. receivers.

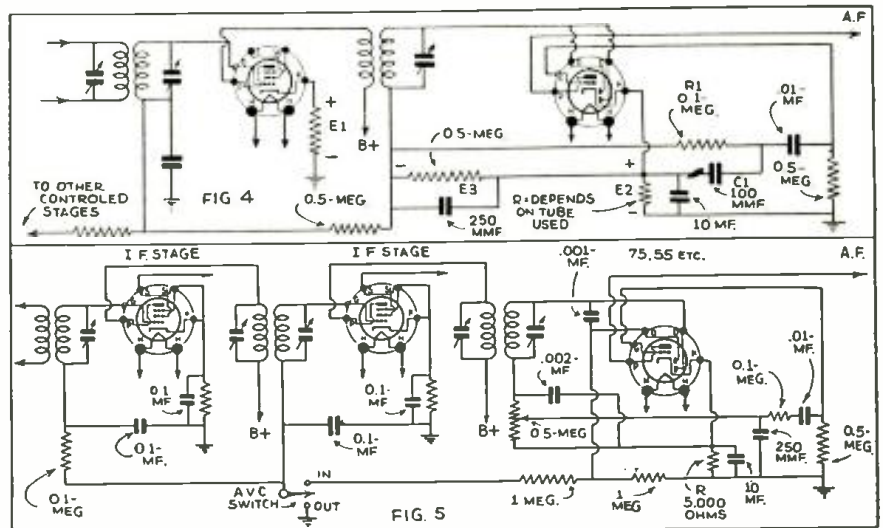

Fig. 4 shows one of the simplest A.V.C. circuits in which a duo-diode-triode is used. Fig. 5 shows a "delayed" A.V.C. circuit

SHORT WAVE SCOUTS

SIXTEENTH "TROPHY CUP" WINNER

Presented to
SHORT WAVE SCOUT
WILLIAM C. PALMER,
CLEVELAND, OHIO.

For his contribution toward the advancement of the art of Radio

by



Magazine

16TH TROPHY WINNER

William C. Palmer, R. 2, Ward Road, Brooklyn Station, Cleveland, Ohio

30 Stations; 23 Foreigns

● THE sixteenth trophy is awarded with pleasure, to Mr. William C. Palmer, Jr., of Cleveland, Ohio. Mr. Palmer had a total of 30 verified stations. Twenty-three of these were foreign, that is, located outside of the United States. Mr. Palmer's receiver was a "19 Twinplex," similar to the one described in the March 1934 issue of SHORT WAVE CRAFT, and his antenna was 75 feet long. Batteries were used to operate the receiver.

We wish to congratulate Mr. Palmer for this very fine log of stations which he picked up on the "19 Twinplex" receiver.

FOREIGN STATIONS

Station call	Date	Location	Meters
CJRX	19/34	Winnipeg, Canada	25.47
DDAS	25/34	Steamship "Bremen"	22.91
DAF	25/34	Zeesen, Germany	23.54
DJA	4/34	Zeesen, Germany	31.38
DJB	29/34	Zeesen, Germany	19.73
DJC	13/34	Zeesen, Germany	49.83
DJD	13/34	Zeesen, Germany	25.51
PRADO	24/34	Rlobamba, Ecuador, S.A.	45.31
FYA	14/34	Paris, France	25.60
EAQ	15/34	Madrid, Spain	30.43
HCJB	26/34	Quito, Ecuador	73.00
HC2RL	24/34	Guayaquil, Ecuador	45.00
HBL	14/34	Geneva, Switzerland	31.30
HBP	14/34	Geneva, Switzerland	38.47
HIX	1/34	Santo Domingo, D.R.	49.50
T14NRH	14/34	Heredia, Costa Rica, C.A.	31.00
VE9HX	1/34	Halifax, Nova Scotia	49.10
YV3BC	8/34	Caracas, Venezuela, S.A.	48.78
CT1AA	28/34	Lisbon, Portugal	31.25
YV4BSG	25/34	Caracas, Venezuela	50.00
HJ1ABB	5/34	Barranquilla, Colombia	46.46
VE9GW	27/34	Bowmanville, Canada	49.22
I2RO	14/34	Rome, Italy	25.40
U.S.A.			
W1XAZ	5/34	Springfield, Mass.	31.33
W8XK	25/34	Pittsburgh, Pa.	25.26
W3XL	15/34	Bound Brook, N.J.	46.70
W1XAL	15/34	Bound Brook, N.J.	49.67
W9XAA	1/34	Chicago, Ill.	49.34
W2XAF	4/34	Schenectady, N.Y.	31.48
W8XAL	29/34	Cincinnati, Ohio	49.50



● ON this page is illustrated the handsome trophy which was designed by one of New York's leading silversmiths. It is made of metal throughout, except the base, which is made of handsome black Bakelite. The metal itself is quadruple silver-plated, in the usual manner of all trophies today.

It is a most imposing piece of work, and stands from tip to base 22 1/2". The diameter of the base is 7 3/4". The diameter of the globe is 5 1/2". The work throughout is first-class, and no money has been spared in its execution. It will enhance any home, and will be admired by everyone who sees it.

The trophy will be awarded every month, and the winner will be announced in the following issue of SHORT WAVE CRAFT. The winner's name will be hand engraved on the trophy.

The purpose of this contest is to advance the art of radio by "logging" as many short-wave phone stations, amateurs excluded, in a period not exceeding 30 days, as possible by any one contestant. The trophy will be awarded to that SHORT WAVE SCOUT who has logged the greatest number of short-wave stations during any 30-day period.

HONORABLE MENTION AWARDS

- First Honorable Mention
Elmer Neuman, 2224 Woodstock Ave., Swissvale, Pa., 22 veris.
- Second Honorable Mention
William Schumacher, 113 Lincoln St., Ellis, Kansas, 21 veris.

Note! All Stations Sent In Must Now Be Verified!

6.—The winner each month will be the person sending in the greatest number of verifications. Unverified stations should not be sent in, as they will not count in the selection of the winner. At least 50 per cent of the verifications sent in by each listener must be for stations located outside of the country in which he resides! In other words, if the contestant lives in the United States at least 50 per cent of his "veris" must be from stations outside of the United States. Letters or cards which do not specifically verify reception, such as those sent by the Daventry stations and, also by commercial telephone stations, will not be accepted as verifications. Only letters or cards which "specifically" verify reception of a "given station," on a given wave length and on a given day, will be accepted! In other words it is useless to send in cards from commercial telephone stations or the Daventry stations, which state that specific verifications will not be given. Therefore do not put such stations on your list for entry in the trophy contest!

7.—This is an international contest in which any reader, no matter where located, can join. It is allowable for SHORT WAVE SCOUTS to list stations in their own countries, if they desire to do so.

8.—SHORT WAVE SCOUTS are allowed the use of any receiving set, from a one-tuber (Continued on page 171)

You wish to know how you can win this valuable trophy, and here are the simple rules. Be sure to read them carefully. Do not jump at conclusions.

1.—A monthly trophy will be awarded to one SHORT WAVE SCOUT only.

2.—The purpose of this contest is to advance the art of radio by "logging" as many short-wave commercial phone stations, in a period not exceeding 30 days, as possible by any one contestant.

3.—The trophy will be awarded to that SHORT WAVE SCOUT who has logged the greatest number of short-wave stations during one month.

4.—In the event of a tie between two or more contestants each logging the same number of stations, the judges will award a similar trophy to each contestant so tying.

5.—Verifications are necessary; these must be sent in with each entry. All cards or verification letters must be sent in at the same time with a statement by the SHORT WAVE SCOUTS, giving the list of stations in typed or written form, with the station calls, wave-lengths, and other able information. (See below.) The verification letters and cards will be returned to the SHORT WAVE SCOUT at the end of each monthly contest. (See Jan., 1933, editorial how to obtain verifications.)

IMPORTANT: Do not fail to remember that all the entries must now be entered according to the new rules which are herewith reprinted for the benefit of those who intend submitting lists of stations. Read the new rules carefully!

Briefly they are: The Trophy will go to the person submitting the "greatest number of verifications!" No unverified stations are required! Also, at least 50 per cent of the verifications submitted must be for stations located OUTSIDE of the country in which the entrant resides. Only letters or cards specifically verifying reception of a given station will be considered.

Trophy Contest Entry Rules

● NOTE that we have amended our rules and you will find that the rules now read:

In order to protect everyone, the rules have been amended that a sworn statement before a Notary Public which only costs a few cents to get, must be sent in at the same time.

For the complete article of the Purpose of the SHORT WAVE SCOUTS, we refer to page 393 of the November, 1933, issue.

Here are the rules amended:

WORLD-WIDE SHORT-

Baird Micro-Wave Transmitter

● THE latest in micro-wave equipment is shown in this view of the new Baird transmitter which has been developed in

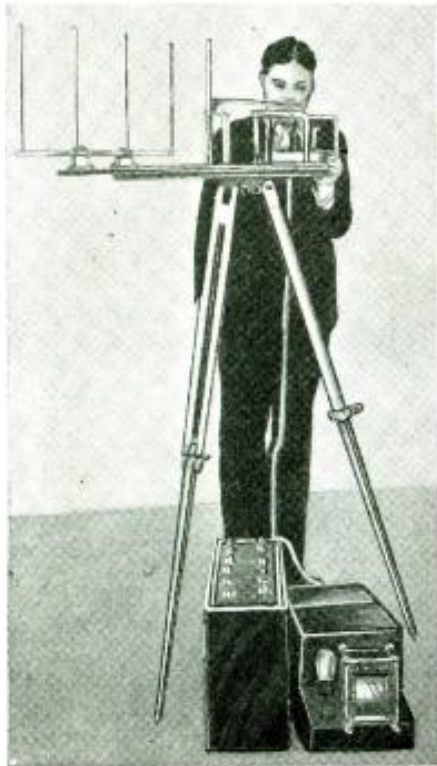

Here is the latest in micro-wave equipment—that devised by Baird, of England.

connection with the Baird television system in England.

This photo of the transmitter appeared recently in *Popular Wireless* magazine. It is interesting to note the short vertical rods extending up from the tripod. These rods are the antenna system of the unit. The remainder of the oscillating system is also mounted on the tripod, as shown, while the power supply units are in the boxes on the floor.

New English 3-Diode Tube

● THERE seems to be no end to the number of combinations that tube engineers

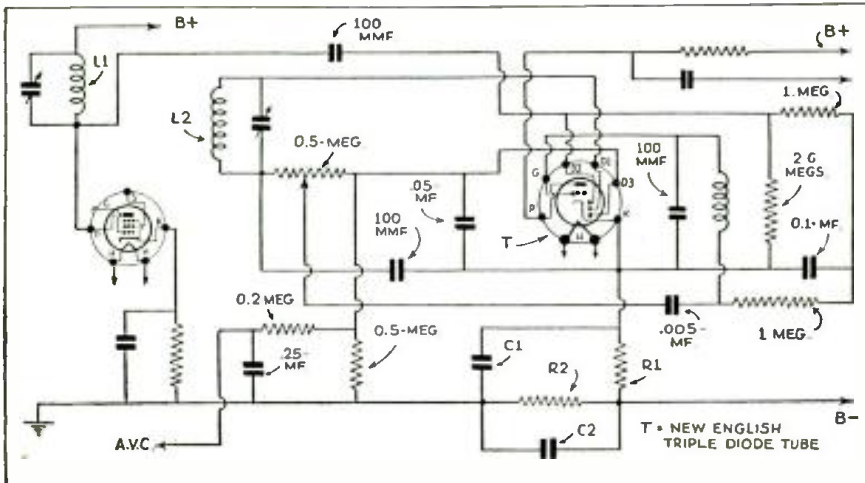

An interesting circuit devised for use with new English "triple-diode" tube, the third diode being used for automatic volume control.

● The Editors have endeavored to review the more important foreign magazines covering short-wave developments, for the benefit of the thousands of readers of this magazine who do not have the opportunity of seeing these magazines first-hand. The circuits shown are for the most part self-explanatory to the radio student, and wherever possible the constants or values of various condensers, coils, etc., are given. Please do not write to us asking for further data, picture-diagrams or lists of parts for these foreign circuits, as we do not have any further specific information other than that given. If the reader will remember that wherever a tuned circuit is shown, for instance, he may use any short-wave coil and the appropriate corresponding tuning condenser, data for which are given dozens of times in each issue of this magazine, he will have no difficulty in reconstructing these foreign circuits to try them out.

can devise to introduce new tube types on the market. One glance at the tube manual of any well-known tube manufacturer will cause the experimenter to throw up his hands in despair.

And in Europe the situation is even worse than in this country. There, tube manufacturers in different countries seem to delight in bringing out new tubes not

superheterodyne sets, especially when all the refinements found in the new commercial sets are to be attained with a minimum of tubes. This new tube consists of a triode and three diode plates, adjacent to the cathode.

This combination of three diodes permits the tube to supply detection, A.V.C. and interstation noise suppression all in one tube—and in addition acts as a stage of A.F. amplification.

Of course, this is not the only way a tube can be used, as the diodes can be used in any combination desired. For example, two diodes can be used for full-wave detection and the third for A.V.C. Or one diode can be used for a tuning indicator in conjunction with a milliammeter and the other two can be used for detection and A.V.C., etc. This listing is by no means complete, as there are many possible combinations in different circuit arrangements which can be applied.

A typical circuit for this new tube is shown here—the first diode is used for diode detection, the second for interstage noise suppression and the third for automatic volume control.

The filament is designed for 4 volts at one ampere. The maximum plate voltage is 250 and the plate impedance is 13,000 ohms. An amplification factor for diode detector and triode A.F. is 35.

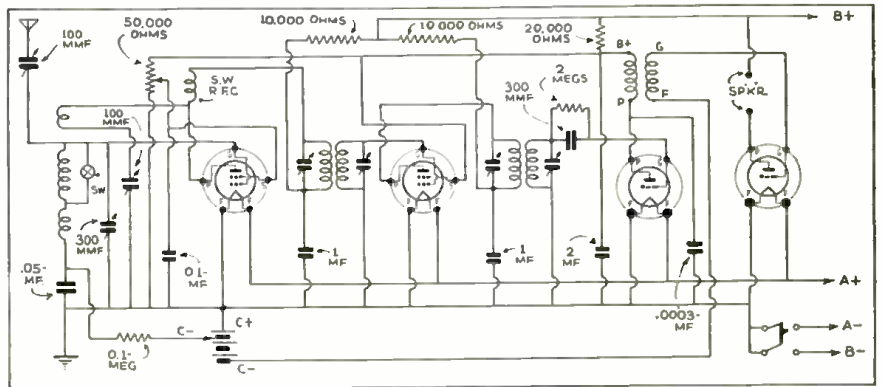

Hook-up of new short-wave superheterodyne in which a screen-grid tube is used as a combination first detector and oscillator.

made by their rivals. This results in complete chaos so far as standardization is concerned.

A recent issue of *Practical and Amateur Wireless*, an English magazine, introduced another new tube—manufactured by "Mazda." This tube has many applications in

A Short-Wave Superheterodyne

● A TYPICAL superheterodyne circuit of English design was recently published in *Wireless Weekly*.

To give our readers an idea of the type of circuit which is most popular across the "big pond" we are reprinting the diagram on this page. The values of most of the parts are indicated.

A glance at the circuit shows that the first tube is a screen-grid type used as a combined first-detector and oscillator. This is followed by a single I.F. amplifier, also of the screen-grid variety. After this come the second-detector of the grid-leak and condenser type, which is transformer-coupled to a triode A.F. amplifier.

The coils are simple—being similar to the coils used for the simple regenerative type of short-wave set.

While this set does not have the pre-selection and freedom from repeat points found in more complicated systems, it is a fine set for learning the principles of the superheterodyne.

Reception on 5 to 10 Meters

● IN a recent issue of *Practical and Amateur Wireless*, three interesting circuits for reception on wavelengths between 5 and 10 meters (the wavelengths chosen for the new English Television broadcasts), were published.

The first circuit which we are reprinting

WAVE REVIEW

Edited by
C. W. PALMER

here is a super-regenerative type. The coils L3 and L4 consist of 3 turns each, of No. 14 wire on a 1-in. dia. form. The coils L1 and L2 which provide the "inter-ruption frequency" consist of 700 turns of

● AN English tube maker—the High Vacuum Valve Co., Ltd., has just introduced a new line of midget tubes which will open up a new line of endeavor for radio experimenters in that country.

While they are not so small as our "acorn" ultra-high frequency tubes, this new line is much smaller than types heretofore available, having a regular "plug-in" base. The filament requirements, too, are extremely economical, so the new tubes will without doubt find many applications in portable, pocket, and similar receivers—both on the short waves and the lower frequencies.

Three tubes are available—a triode having an amplification factor of 16; another triode with an amplification of 12; and a screen-grid tube having an amplification factor of 360. The filaments of these three types, which are all of the direct filament type operate at 2 volts and consume .06 amps.

The announcement of these tubes, which appeared in *Wireless World* stated that samples of all three types had been on test by the British Government for some months and that they had withstood many rigorous tests.

While these "valves," as they are called in England, have not been particularly designed for short-wave receivers, they are said to have fine characteristics for this purpose.

An Ultra-Short Wave Converter

● AN issue of *Practical and Amateur Wireless* (London) recently contained the circuit of a converter to be connected to a broadcast receiver to pick up the broadcasts below 10 meters which have recently started in connection with television activities in England.

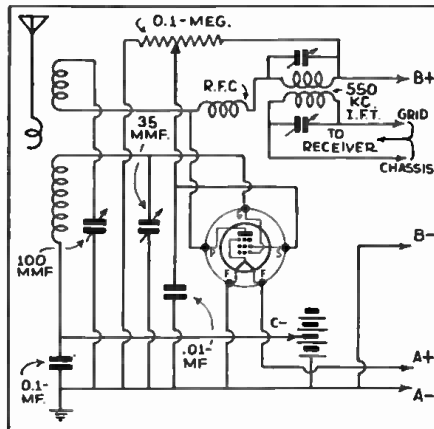

Simple wiring diagram of an ultra short-wave converter, which will undoubtedly interest our American short-wave "Fans."

This converter is in most respects the same as those used for ordinary short waves, but the aerial coil is not grounded as most coils are. Instead, it hangs open and is connected at one end only, to the aerial.

The plate circuit of the converter tube which is an R.F. pentode, such as the type 34, is coupled to an I.F. transformer tuned to about 550 kc. which is the upper limit of most broadcast sets. This coil should be tuned to a frequency at which no broadcast station comes in, on the set, to prevent interference.

The values of the condensers as resistors are indicated on the circuit. The tuning condenser has a value of about 35 mmf. while the regeneration control has a maximum capacity of 100 mmf. A "C" battery supplies the bias to the tube which is battery-operated.

The I.F. coil should be connected to the grid of the first tube in the broadcast set,

instead of the aerial coil as is the usual method. This is because the I.F. transformer has a high resonant impedance, which would not match the aerial coil of most sets, thus causing a great loss in signal transfer.

The grid coil contains four turns of No. 16 wire on a form 1 in. in diameter. The plate coil will require 3 turns while a single turn makes up the aerial coil. The three coils should be spaced about 1/2-in. apart and the turns should be spaced about 1/2-in. This coil will cover a wavelength range of about 4.5 to 6.5 meters. Other coils can be made to cover the other ranges from 6.5 up to about 15 meters.

Interesting Tuning Meters

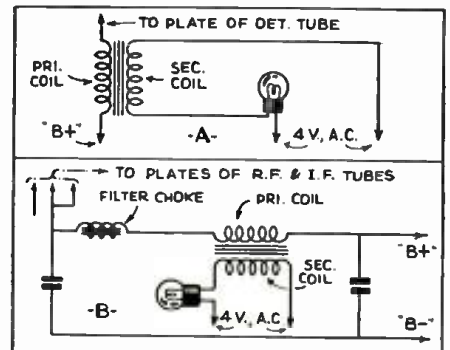

Two interesting tuning meter circuits of French origin.

● THE general acceptance of the super-het. circuit as the best for short-wave and all-wave receivers has introduced problems which were not encountered with the T.R.F. and regenerative types of circuits.

One of these is the necessity for tuning the set exactly to the frequency of the broadcasting station to prevent distortion of the programs.

To answer this, most commercial super-heterodyne sets use some form of tuning indicator to give a visual indication of resonance. In a French magazine—*L'Accessoire et la Piece Detachee* (a new magazine to appear in this digest)—several interesting varieties of tuning indicators were described recently.

The first consists of a transformer which is inserted in the plate lead to the detector tube. This transformer is made in such a way that the core becomes saturated when the current exceeds a certain value. The secondary is connected to a flashlight type of bulb and a source of A.C. to light the filament.

The light burns dully until a signal is tuned in, after which it increases in brilliance until the set is tuned exactly to resonance with the station. This is caused by saturation of the iron core, which decreases the impedance of the secondary winding to the flow of current from the A.C. source. As the primary (detector plate current) increases, the secondary impedance decreases more and more with a corresponding increase in brilliance of the light. In the grid-leak type of detector, of course, the action is reversed, as the detector plate current decreases with an increase in signal strength.

The same system can be used in the A.V.C. circuit of a set, providing the current change is sufficient.

Another scheme, shown in the accompanying illustration is to use the change in plate current for the entire set, when a signal is being received. Here the coil is placed in series with one of the filter chokes, in the "B" supply.

No exact details are given for the coil or core, except to state that the primary is wound with a great many turns and the secondary has about one-tenth the number wound on the primary.

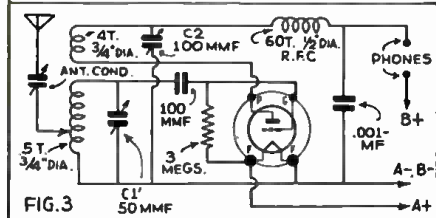
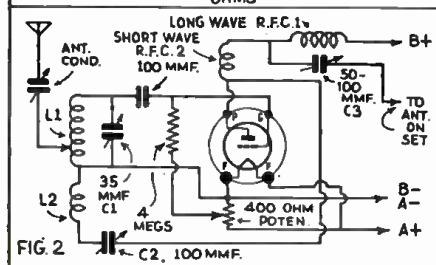
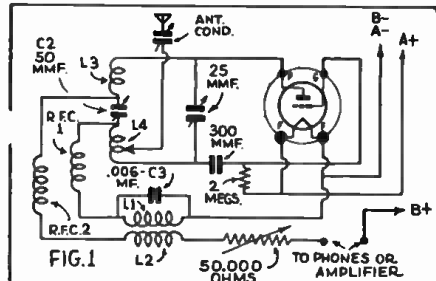

Three diagrams of 5 and 10 meter apparatus described in accompanying text, third circuit using "series reaction" control.

fine wire (about No. 36) jumble-wound (helter-skelter) on a form 1 inch in diameter. The chokes, RFC1 and RFC2 consist of 60 turns of No. 34 S.S.C. wire on a form 1/2 in. in diameter.

The second circuit is the well-known Reinartz regenerative arrangement, in the form of a short-wave converter. The coils L1 and L2 contain four turns of No. 16 wire on a form 1/2 in. in diameter. The R.F. chokes should be designed—one for short waves and the other for longer wavelengths.

The third circuit is called a "series-reaction" arrangement and is a complete 1-tube set. The coil constants, as well as values of capacity and resistance for this circuit are indicated on the wiring diagram.

New Midget Tubes



The latest idea in "midget" tubes from England.

WHAT'S NEW

In Short-Wave Apparatus

The short-wave apparatus here shown has been carefully selected for description by the editors after a rigid investigation of its merits

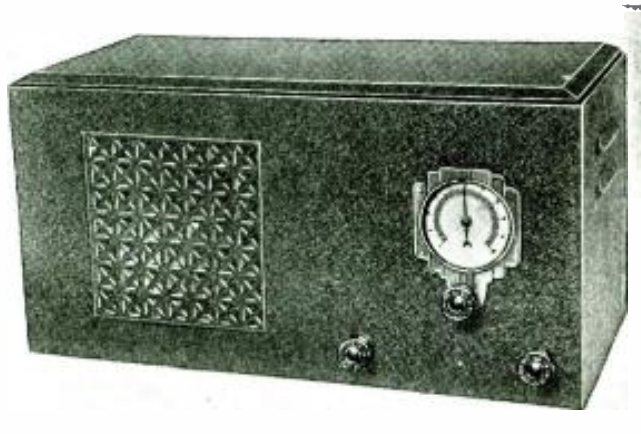

The HG-35 All-Wave Set

By Guy Stokely*

and 2A5 as the power pentode audio amplifier. The 2A5 tube, well known for its high-power sensitivity, produces great volume on most of the signals. The type 84 full-wave high vacuum rectifier tube is used in preference to the more common 80 on account of its lower internal voltage drop.

The volume control R1 is an absolute necessity with this receiver. By its use the signal strength may be varied from a whisper to a roar on most stations. This is an excellent indication that the R.F. amplifier is functioning properly and that considerable gain is being realized from this stage. This gain is evident on all waves even as low as 10 meters. Electromagnetic coupling (3 winding coils) is used to feed the output of the R.F. amplifier into the grid of the detector. This method of coupling results in a considerable increase in selectivity over the more common two-winding coil method. The primary winding of the plug-in coils have been designed so that they offer an excellent impedance match with the plate circuit of the 58 R.F. amplifier, and results in the aforementioned gain resulting from this stage. Grid leak-condenser method of detection is used due to its high sensitivity. The plate by-pass condenser, plate resistor, and number of turns per tickler coil have been so proportioned as to permit regeneration (Continued on page 181)

Note the neat appearance of the HG-35 All-Wave Receiver here described. No. 288.

● THE new Eilen HG-35 ALL-WAVE receiver is complete in every detail and has been designed for the short-wave fan who demands real results. In it has been incorporated all of the details which are so essential to proper reception of short waves.

As a short wave broadcast receiver, it produces unusually good results, having been designed so as to produce regular broadcast receiver volume on foreign S-W stations. It also makes an excellent amateur band receiver where sensitivity and consistent reception of far distant stations are of prime importance. CW telegraph and telephone stations are reproduced with enormous volume. Band-spread tuning is built into the receiver so as to permit easy tuning in foreign broadcast bands as well as in the crowded amateur bands. Plug-in coils, well known for their low electrical losses, are used in order to attain the highest possible efficiency. These coils enable the entire wavelength range of 10-600 meters to be covered in six steps. A built-in dynamic speaker and complete power supply eliminates the need of any accessories with this model.

Inspection of the circuit diagram reveals the use of five of the "high-gain" types of tubes, i.e. 58 functioning as R.F. amplifier, 58 (or 57) as regenerative detector, 56 as first audio amplifier,

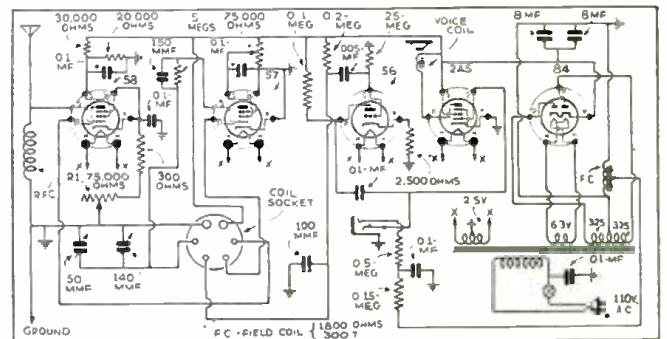

Wiring diagram for the HG-35 All-Wave set.

*Ellen Radio Laboratories.

New All-Wave Tuning Coupler

● THE doublet antenna has rapidly risen to a very important position among short-wave appliances and practically every dyed-in-the-wool short-wave fan today is either using some form of doublet antenna or contemplating the erection of one. One of the newest devices designed to enable the short-wave listener to match the impedance of the antenna to that of his receiver is the Muter All-Wave Tuning Coupler. This coupler is located as close

to the receiving set as possible and after the coupler has been connected by following the simple instructions supplied with the coupler, all that the operator has to do is to tune in a station, preferably, a weak one, and then adjust the switch on the Antenna Coupler until the maximum strength of signal is heard on the phones or loudspeaker. No ground connection is used with this coupler and the output wires of the coupler simply connect to the aerial and ground binding (Continued on page 177)

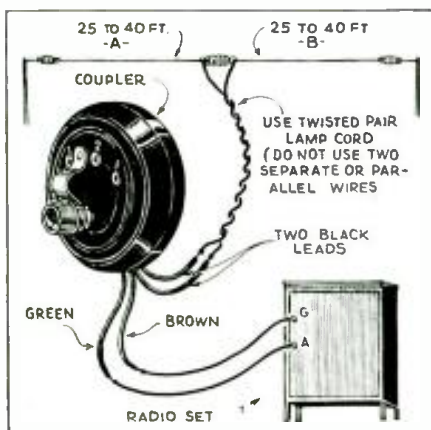

One of the newest All-Wave Antenna Tuning Couplers. No. 289.

Names and addresses of manufacturers of sets described on this and following pages furnished upon receipt of 3-cent stamp; mention No. of article.

Transmitting Inductance Switch

● TO THE amateurs who wish to simplify the construction of their short-wave transmitters, this new Ohmite switch offers great possibilities. Several of these switches can be incorporated in an up-to-the-minute transmitter and allow changing instantly from one band to the other. These switches have three extra heavy contacts which are built into a strong porcelain base. This switch will allow the transmitter to be operated on any one of the three amateur bands at a moment's notice.

Tests have shown that there are no appreciable losses in the tuned circuit, providing the unused turns are shorted to the low potential end of the coil.

Of course it would be rather difficult to use a switching system on a push-pull amplifier or oscillator. However, the amateur who is going in for simplicity does not usually use push-pull stages. The output stage of a transmitter would have one of these switches to short out turns in the plate tank coil, and one for the antenna coil. If the well-known impedance matching network is used in the antenna circuit, these switches will serve to change rapidly from one band to the other.

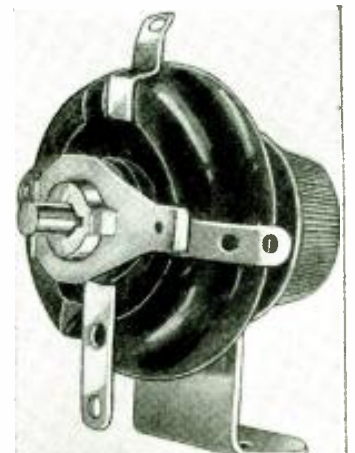

An Inductance switch for your Transmitter. No. 290.

New Short-Wave Converter

By Louis B. Sklar

black cabinet which may be carried about easily, inasmuch as it is provided with a convenient handle. The photograph shows the front view and also indicates the compartment in the rear which is opened when the plug-in coils are changed. In referring to the diagram, we notice that the converter operates with a ground; however, there is connected in series with the ground terminal a small bulb which will prevent the house fuses from being blown, should the power supply plug be inserted in the wrong direction.

Should the 110 v. plug be wrongly inserted the safety lamp will light up, indicating that the plug is in the wrong position. Reversing the plug the light will remain dark, showing that the position of the plug is o.k. and the chassis parts are at ground potential.

When the set is plugged in into the 110 v. A.C. socket and the safety light is dark, it still does not mean that the set is grounded; it is very possible that you have a faulty grounding system and the safety lamp cannot become energized. It is therefore best in every case to try both positions of the plug to make sure that your ground is o.k. If the safety light remains dark, regardless of position of the electric plug, the best thing to do is not to operate the set until you make sure that your ground (Continued on page 180)

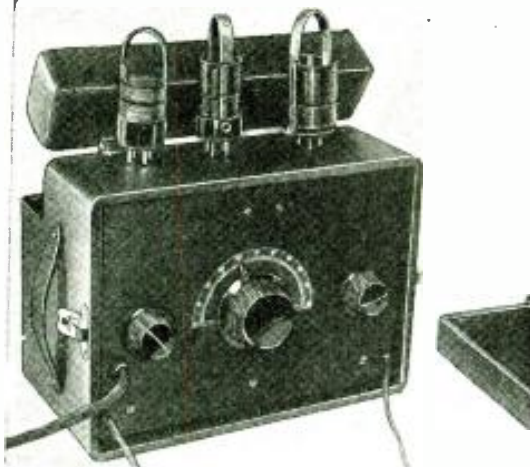

With this short-wave converter you can hear short-wave stations on your broadcast set. No. 291.

● HERE is quite a novel and very effective short-wave converter. It uses 2 tubes, a 6A7 pentagrid converter for the first detector and oscillator stages, and a 37 rectifier. This converter is entirely self-powered and will work on 110 volts either A.C. or D.C.

The "Airkor" S-W Converter is housed in a neat

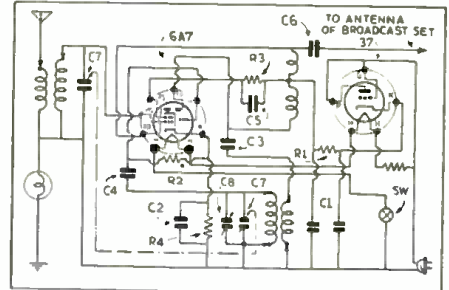

Here is a simple hook-up of the parts used in the S-W. converter.

Real New! Piezo-Electric Headphones

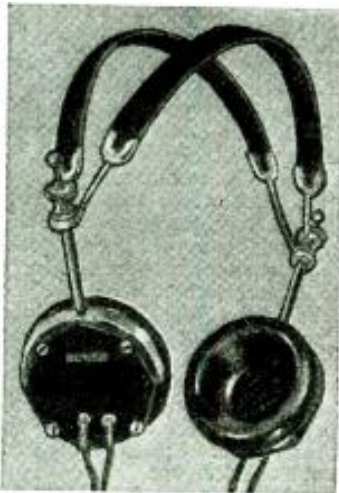

These phones use crystals instead of coils and magnets. No. 292

● THE latest advancement in earphone design is the new brush type A Piezo Electric headphones.

These phones do not have the usual wire-wound pole-pieces. The entire instrument is built around two crystal plates, each 5/8-inch square by .010 of an inch thick. These are cut from large Rochelle Salt Crystals. These earphones have an impedance of 50,000 ohms at 1,000 cycles, and have a response of from 60 to 10,000 cycles. This is an extremely wide range and makes them applicable to any type of electro-stethoscopic work where the higher frequencies are especially important.

These earphones cannot usually be connected into positions ordinarily used for the standard

types. It is necessary to insert small condensers in series with the phones and provide a load for the plate circuit of the tube with which they are being used. This load can be either in the form of an inductance or a resistor depending upon the principal characteristics of the circuit. The diagrams clearly show the methods of connecting these phones to the output circuit of a vacuum tube.

The crystal element in these phones drives a 1 1/2-inch cone. The driving mechanism of the Piezo-Electric phones is assembled in a distinctive brown octagonal bakelite case. They are fireproof and made of durable light weight material. The entire assembly including receivers and head-band weighs only six ounces.

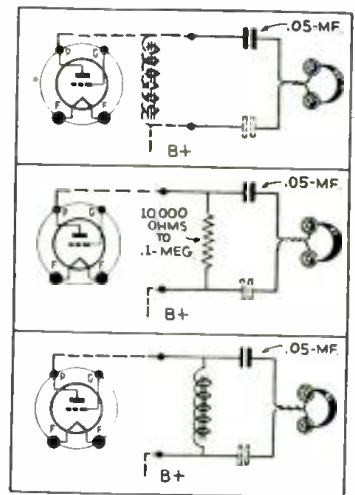

How crystal phones connect to radio set.

Metal Radio Tubes Mark New Departure

● ONE of the most radical changes in radio apparatus design in the past 20 years is the new all-metal tube announced by the General Electric Company, and which will be marketed by the RCA Radio-Iron Corp. These tubes, models which were shown to engineers and editors a few weeks ago in New York City, in general, run considerably smaller than their equivalent glass tubes. As the accompanying drawing shows, the tube is really formed of two steel shells which are electrically spot-welded together. The air is exhausted through the central evacuating tube, this tube being sealed off when the proper degree of exhaustion has been attained.

The leads from the various elements in the tube are carried out through the bottom steel header, through glass beads which are fused into eyelets made of *fernico*, a metal alloy

which has the same expansion coefficient as glass, the result of much research.

A standard eight-pin socket is used for all of the tubes; the tube is easily located for proper position, due to the fact that a key is formed on the central stem, which engages with a slot cut in one side of the center hole. Ten types of these metal tubes have been developed so far, with 6.3 volt filaments.

Thus far the metal tubes developed and being made ready for the market are the equivalents of the standard well-known glass tubes, including triodes, screen-grid, A.F. power output, and also rectified tubes. Aside from the standard types there are new tubes being planned, including a double diode and a hexode, which is an improved pentagrid-converter.

One of the main features of these new tubes is their unbreakable nature, and next we note that the metal shielding of the tube, aside from the fact that it is a better heat conductor and (Continued on page 180)

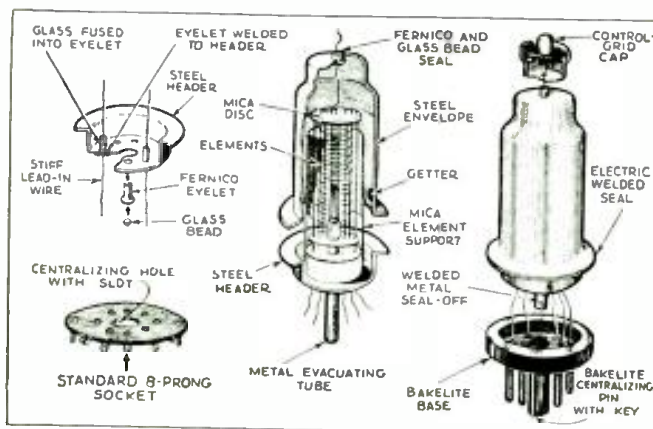

Construction details of new "metal" radio tubes. No. 293.

Names and addresses of manufacturers of sets described on this and following pages furnished upon receipt of 3-cent stamp; mention No. of article.

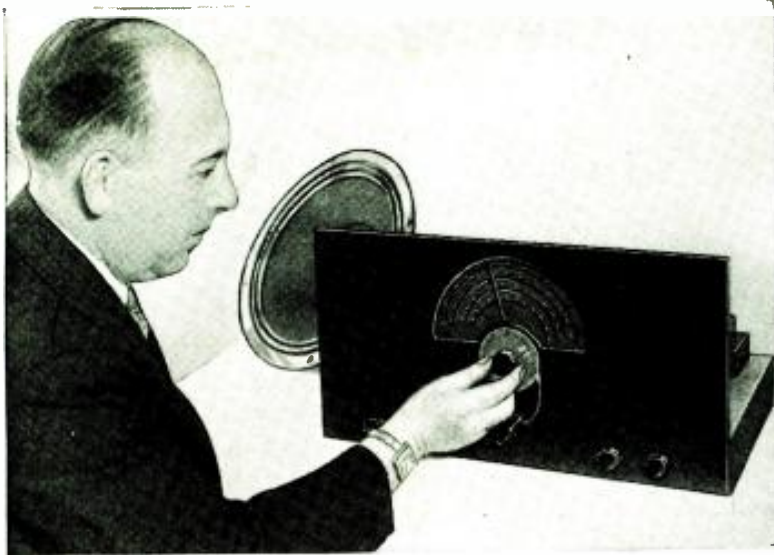

One of the important features of the Browning 35 "All-Wave" receiver is that continuous band-spread is available on all bands.

The "BROWNING 35" - All-Wave Receiver

By Glenn H. Browning

The Browning 35 receiver was especially designed to be readily assembled by the average short-wave experimenter and it provides "band-spread" on all bands. The set covers the complete range from 13.2 to 555 meters.

● **FUNDAMENTALLY**, the only real excuse for a radio receiver in kit form is that it should provide a better set for less money where the builder is willing to do his own assembling and wiring. The complete set market is surfeited with cheap and medium-priced sets built on a large production basis which give fair or indifferent results. Such receivers are usually worth about what they cost and are cheaper to buy than to try to build. But in the more exclusive field of really high-class radio receivers the market is far from being overcrowded. The few sets of this type which are available are expensive and beyond the reach of the average radio fan's pocketbook.

It was to meet the requirements of the radio experimenter who wants the finest results and who is willing to do some of the work himself to obtain them economically that the "Browning 35" was developed.

Low "Noise-Level" Boosts DX
In designing this receiver we have

had constantly before us certain requirements which must be met:—

In the first place it should be a really fine modern receiver, which meant an *all-wave* superheterodyne incorporating a stage of *efficient* radio frequency amplification on *all* bands.

Secondly, it must have a satisfactory *quality-selectivity* compromise. It is a simple matter to design an ultra selective receiver with poor reproduction characteristics. Or, good reproduction is no problem if broad tuning is allowed. Combining these two requirements in the same set is a different story and requires the utmost care in circuit design.

Next this receiver must be capable of not only *good* long distance reception but of the very finest distance reception possible with present tubes and standard equipment. We have persisted in this requirement from the beginning, as much of the pleasure and fascination in an all-wave set lies in the satisfactory reception of *foreign* stations. To accomplish this result, (and

we feel that we can safely say that it has been accomplished in the "Browning 35") one requirement stands out above all others, namely, a low *noise-level!* Adequate sensitivity is of course necessary but if carried too far this is often more of a liability than an asset. What we are after is good signal volume with the *least possible noise.*

In general, these are the features which distinguish the really fine radio receivers from the mediocre ones. Our final requirement, which was the most difficult of all to meet, was that this receiver should be so designed that it could be easily assembled by the *average* radio experimenter, with the assurance that when the job was completed it would retain all of these desirable characteristics.

This last requirement, which we confess seemed almost insurmountable at first, was finally accomplished by the use of a new piece of radio equipment—the **TOBE SUPER-TUNER.**

(Continued on page 174)

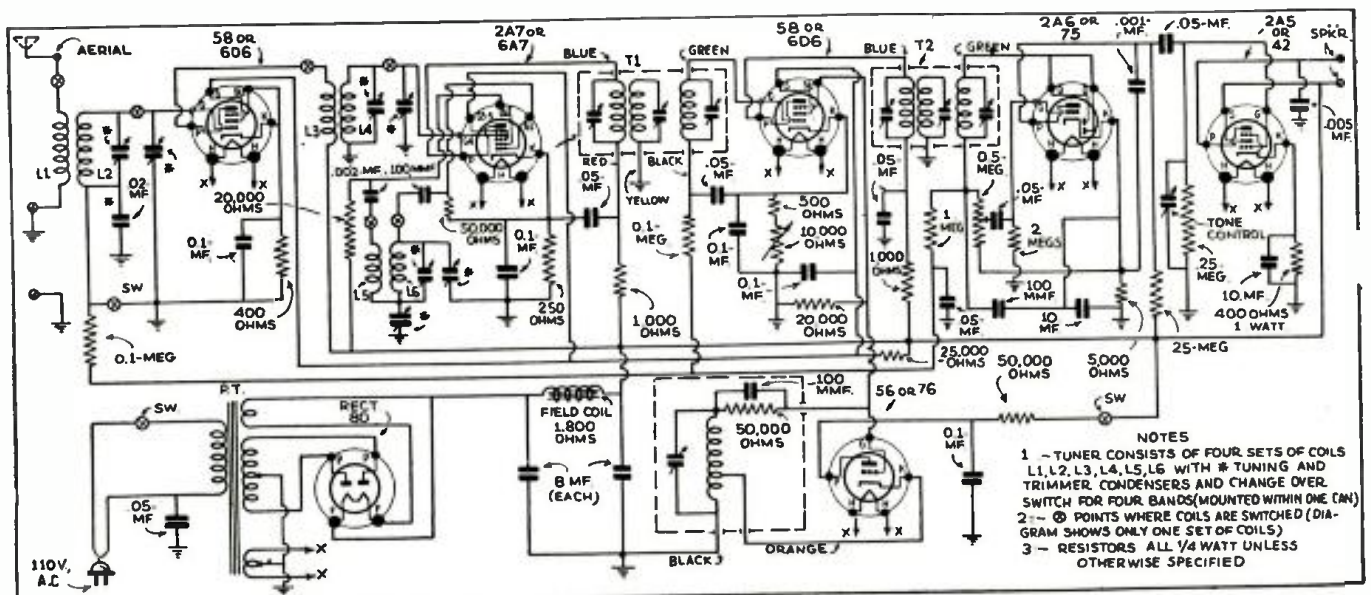

Wiring diagram for the Browning 35, showing the simple and straightforward arrangement of the various stages, including the beat oscillator.

A Practical MOBILE STATION

By Maurice E. Kennedy W6KQ-W6BCC

Technical Director, Station KFSG



Here is a very interesting and practical design of a 5-meter Transceiver, which has distinguished itself by the excellent performance it has rendered, especially in transmission. Excellent voice communication was maintained for over an hour with a station located 30 miles distant, with a 1,500 foot mountain intervening!

Photo above at left shows the author standing alongside the car in which the mobile 5-meter Station is carried. The telescopic antennas are shown secured to either rear bumper. Photo at right shows complete mobile unit, built in a tool case.



● WHEN the Federal Communications Commission opened the ultra-high frequency bands for mobile use, we recognized the great opportunity to study antennas, shadow effects, radiation phenomenon, and the thrill of voice communication from your car. Most broadcast men are hams and experimenters at heart, and being no exception, we could see an outlet for hundreds of ideas and experiments.

After building and rebuilding at least a dozen transmitters, receivers, transceivers, and antennas, we designed and built the described efficient yet simple mobile type station.

The transceiver is similar to others in common use and can hardly be considered outstanding in design. It is mounted in a steel tool case and has proved to be superior to many of the more complex types of transceivers since developed. Power is supplied by the vibrator type power supply of a broadcast receiver which was rewired to accommodate a 3-circuit telephone jack. This supplies 225 Volts D.C. at 50 milliamperes which is a decided improvement over the dry battery power supplies in use by most transceivers.

The transceiver consists of a type 71A oscillator-detector and a 112A tube as modulator-low frequency generator. When the multicontact switch is

thrown to the *transmit* position this tube combination will radiate a strong, 3-watt, well-modulated signal. With the control switch in the *receive* position, the 71A tube becomes a sensitive detector and the 112A an interruption-frequency oscillator. Most signals are so loud that the headphones must be pushed forward and away from the operator's ears for comfort in reception.

The Antenna

The antenna is the result of months of spare-time experiment and has more than repaid us with results. The vertical antenna is constructed of a 4-foot section of brass pipe mounted on stand-

off insulators above the back bumper. The top section of the antenna is a 4½ foot, ⅜-inch diameter brass rod which telescopes into the hollow pipe. For transmitting, the antenna is extended to the desired length, usually about eight feet, and is held in place by tightening the thumb-screw at the top of the lower section. On the opposite side of the spare tire and exactly a quarter wavelength from the antenna is mounted a similar vertical pipe and rod type reflector. For mobile use the reflector is seldom used and may be reduced to four feet. The antenna is reduced to six feet, which necessitates operating at the high frequency end of the 5-meter band. This is more convenient for driving in traffic and where the fully extended antenna would be apt to brush against low-hanging bushes and trees.

On the day off this mobile station usually finds its way to the top of a hill, and once parked in a suitable spot, the antenna is extended to 8½" and the reflector to 8' 3 and ¼" for 58 M.C. operation.

The antenna has been fed in a number of different ways, but a low impedance line has proved the most satisfactory. Not being satisfied with the high insulation loss of the lamp-cord feeder used until recently, we designed

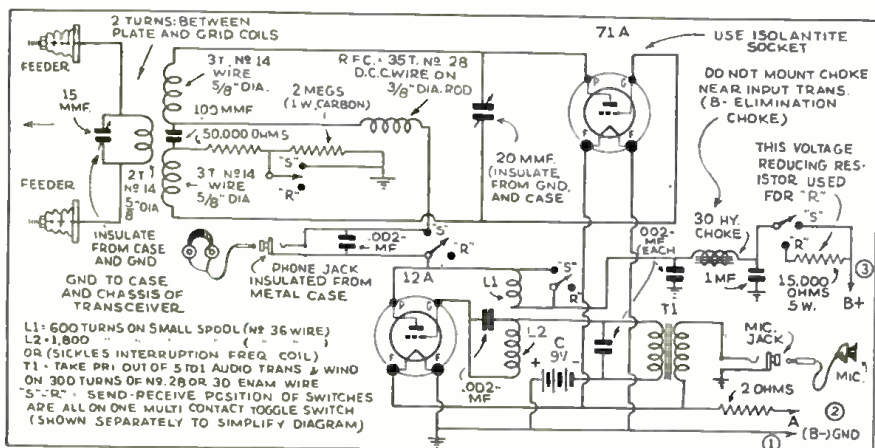
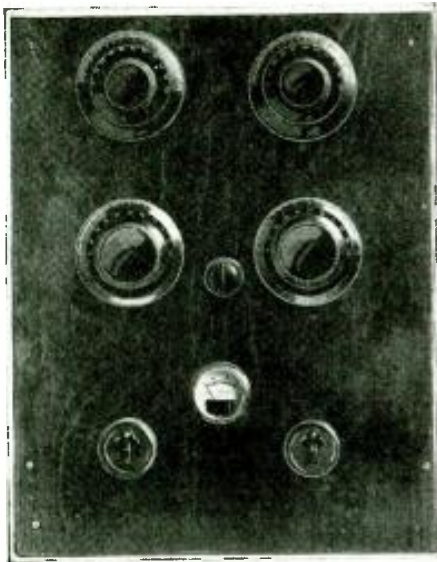

Diagram of connections used in building the portable 5-meter transmitting and receiving station here described.

(Continued on page 178)

The Simplest PHONE Xmitter

By STANLEY JOHNSON W9LBV



Front view of the "Simplest Phone Xmitter"

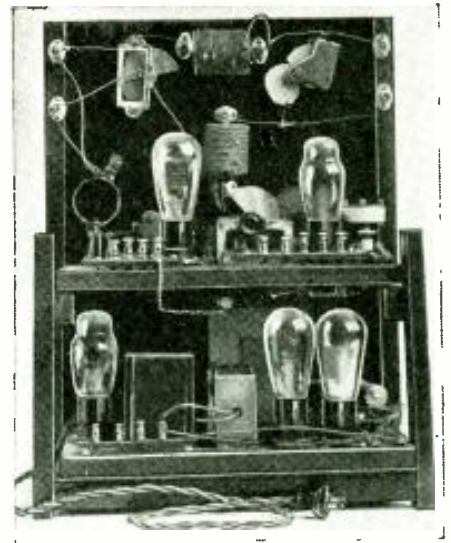

Rear view of the transmitter described by Mr. Johnson

This transmitter uses a novel modulation system—as effective as it is simple and inexpensive. It uses low power on 160-meter phone, also 80-meter C.W.

● EVER since he began in amateur radio, W9LBV had been a C.W. operator. The reason was simple: phone transmitters cost too much. He would probably still be exclusively a brass-pounder if he had not learned of a unique modulation system, a system that makes a "low-priced" phone transmitter a possibility. Unlike Heising modulation it requires no expensive transformers, modulation chokes or powerful modulator tubes; unlike grid modulation, it doesn't cut the output of a transmitter to a fraction of what it was on C.W. Instead, the only parts used are three inexpensive tubes, a couple of small resistors and two ordinary audio transformers. No new power supplies are necessary: the modulator tubes draw no additional plate current.

Series Modulation Used

This unique system is known as "Series" modulation. The circuit in its present form was developed in the midwest, where its use is spreading rapidly. Its popularity lies in that it allows an amateur to make his C.W. transmitter into a radiophone with a very minimum of equipment. The system may be applied to any good C.W. transmitter, either a MOPA or a crystal-controlled "rig." To add series modulation to an

existing C.W. transmitter, it is only necessary to place it in the B-minus lead between the power supply and the final amplifier. No other changes are necessary. It can be applied to 5-meter transmitters, where a simple modulation system is especially desirable, as well as to low-frequency transmitters.

This Xmitter "Steps Out"!

Now that we have learned what is behind the circuit let us consider a complete transmitter, built especially to use this modulation system. W9LBV is a college student and it was necessary to build a transmitter both compact and inexpensive, yet with enough power to "get out," consistently. This little transmitter, whose panel measures only 16x20 inches, has made it possible to QSO, regularly, on 160-meter phone, stations hundreds of miles distant. On 80-meter C.W. it is equally effective; good reports have been received from both coasts.

The transmitter is built up in simple rack-and-panel style. The little rack is made from 1x2 inch wood and holds two baseboards, on which are mounted the crystal oscillator, amplifier, power supply, speech amplifier, and modulator. The antenna matching system is mounted on the back of the panel, near the top. Looking at the panel from the front, we see four dials, for tuning the oscillator, amplifier, and antenna system, a knob for the neutralizing condenser, a milliammeter, and two switches. One of the switches is to change from phone to C.W. and the other is in the 110 volt line.

The power supply, modulator, and speech amplifier are all mounted on one of the baseboards, which measure 10x14 inches. This unit is the lower of the two shown in the photograph of the back of the transmitter. A Victor replacement power transformer supplies the voltage. This particular transformer was chosen because it has a high voltage winding of 800 volts, center-tapped, and has two 2½ volt windings to supply the modulator and amplifier filaments. There is also a 1½ volt winding which is used for the 26 speech amplifier and a 5 volt winding to light the 83 rectifier tube. While

(Continued on page 179)

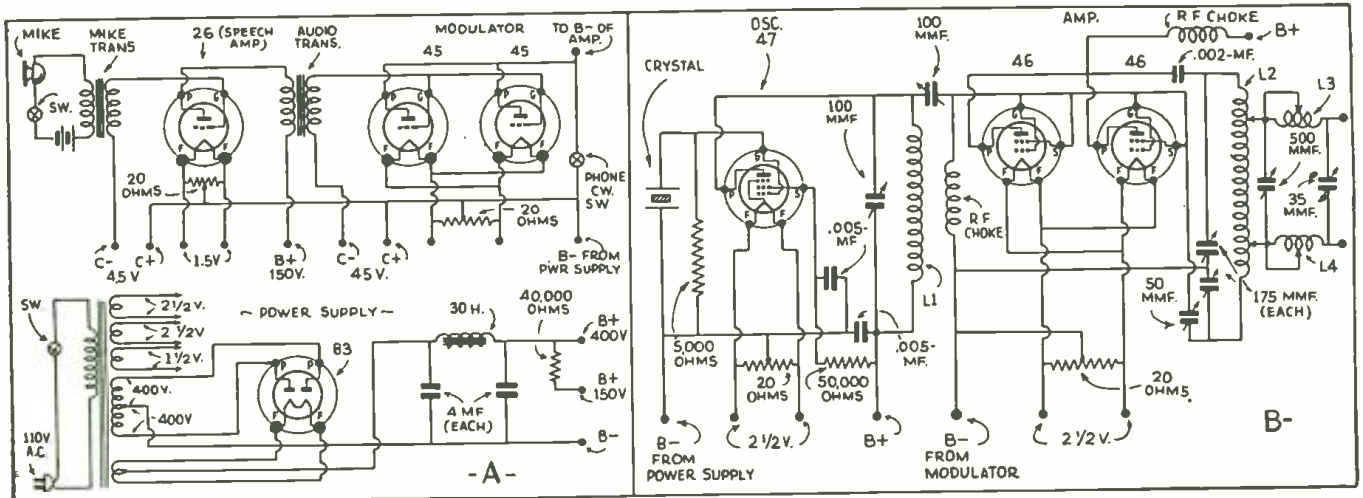

Wiring diagram of the low-priced phone transmitter here described by W9LBV, together with speech amplifier. No expensive tubes or parts are necessary.



Here is the newest all wave set that under actual tests by qualified authorities, has demonstrated its superiority over receivers costing several times as much. It includes the TOBE TUNER, the heart of the Browning 35. This tuner is a pre-adjusted unit including all R.F. tuning circuits.

The TOBE TUNER comes to you completely wired and aligned ready to be set into the chassis with only seven simple connections.

Full details mailed FREE

Special discount to experimenters and servicemen. Order direct from your jobber listed below.

BUFFALO, NEW YORK Radio Equipment Corp. 161 Genesee St.	NEW YORK, NEW YORK Try-Mo Radio Co., Inc. 85 Cortlandt St.
CHICAGO, ILLINOIS Allied Radio Corporation 833 West Jackson Blvd.	PHILADELPHIA, PENNSYLVANIA Radio Electric Service Co., Inc. N. E. Cor. Seventh & Arch Sts.
CHICAGO, ILLINOIS Chicago Radio Apparatus Co., Inc. 415 South Dearborn Street	PHILADELPHIA, PENNSYLVANIA Eugene G. Wile 10 S. Tenth Street
CHICAGO, ILLINOIS Newark Electric Company 226 W. Madison Street	PITTSBURGH, PENNSYLVANIA Tydings Company 620 Grant Street
DES MOINES, IOWA Iowa Radio Corporation 1212 Grand Avenue	PROVIDENCE, RHODE ISLAND W. H. Edwards & Company 32 Broadway
ERIE, PENNSYLVANIA J. V. Duncombe Co. 1011 West 8 St.	READING, PENNSYLVANIA George D. Barbey Co. 404 Walnut St.
KANSAS CITY, MISSOURI Burststein-Applebee Company 1012-14 McGee Street	ST. JOSEPH, MISSOURI Utz Electric Co. 12th & Faraon Sts.
MILWAUKEE, WISCONSIN Radio Parts Company, Inc. 332 West State Street	SCHENECTADY, NEW YORK M. Schwartz & Son 710-712 Broadway
NEW YORK, NEW YORK Fischer Distributing Corp. 152 Chambers Street	SHREVEPORT, LOUISIANA Dunkelman-Pace 1417 Louisiana Avenue
NEW YORK, NEW YORK Sun Radio Company 227 Fulton St. (Cor. Greenwich St.)	SPOKANE, WASHINGTON Spokane Radio Company, Inc. 611 First Avenue

Metal Radio Tubes Mark New Departure

(Continued from page 153)

radiator than glass, serves as its own shield for the elements within. This metal shield is connected to the chassis or ground through an extra base pin provided for the purpose.

One of the distinct new features of these all-metal tubes lies in the reduced length of lead wires connecting the pins with the elements, which will make them much more effective for short-wave reception, particularly where they are used in modern all-wave receivers.

Due to the much closer proximity of the elements to the metal base and the shorter leads, much greater amplification is achieved at the higher frequencies, the inter-electrode capacity being approximately one-third of the capacity obtained with the equivalent glass tube.

The very effective shielding also provides greater stability to the set. One of the principal reasons for bringing out the metal tube is the early introduction of a new line of receiving sets which will be fitted with these all-metal tubes. The metal shells of the tube are made of steel about 1/32 of an inch. Currents as high as 100,000 amperes are used in spot welding the steel tube and the bottom shell together.

New Short-Wave Converter

(Continued from page 153)

lead-in is firmly connected to a water pipe or any other substantial grounding system.

The photograph also shows the special low-loss coils which are supplied with the converter. These are practically self-supporting, inasmuch as they are wound above the base and supported by the handle of the coil. With the aid of this converter, short-wave programs can be heard on any fairly sensitive broadcast (200 to 550 meter) receiver.

A new type short-wave plug-in coil (Fig. 1) is used. Manufacturers of radios have long ago discarded the old type high-loss bakelite-frame variable condenser. The modern variable condenser uses a minimum of insulation to insulate the stator from the rotor. Very little, however, has been done to decrease the amount of insulation on short wave plug-in coils.

This coil called "AIRKOR" is the only plug-in coil using a minimum of insulation to support the windings. The value of the "AIRKOR" can be appreciated more fully when a distant station is tuned in and a tube made of bakelite or other insulating material is slipped over the coil. When that is done the station immediately disappears; retuning is required to bring the station back, but it will never come back with the same volume unless the power is greatly increased. You can therefore readily see the advantage of the increase in efficiency of these coils compared with the old type coils wound on high loss coil forms.

Short Wave League Members
IDENTIFY THEMSELVES WITH THE ORGANIZATION



In order that fellow members of the LEAGUE may be able to recognize each other when they meet, we have designed this button, which is sold only to members and which will give you a professional appearance.

If you are a member of the LEAGUE, you cannot afford to be without this insignia of your membership. It is sold only to those belonging to the LEAGUE and when you see it on another, you can be certain that he is a member.

See page 190

Lapel Button, made in bronze, gold filled, not plated, prepaid..... 35c
Lapel Button, like one described above, but in solid gold, prepaid.....\$2.00

Know Thyself!

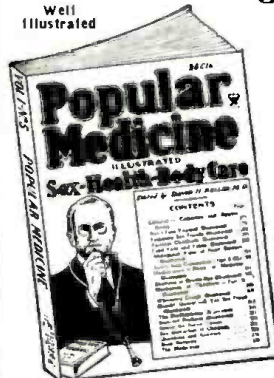

This new monthly magazine is also your own doctor. WHAT AILS YOU? POPULAR MEDICINE tells and advises you thoroughly. Written for you by doctors. Non-technical yet authoritative for all laymen. Many anatomical illustrations.

Special Offer!

8 Months \$1 for 1

Send 15c for sample copy
POPULAR MEDICINE

97C Hudson St.
New York, N. Y.
On All Newsstands

SERVICE MEN— Get YOUR Share of \$400 in Prizes!

● RADIO-CRAFT for July contains Rules and complete information concerning a special contest, open to EVERY Service Man, to determine just what test equipment is required in order to service radio sets with least labor and greatest speed.

"The Ideal Radio Service Shop" is the title of the contest. It costs nothing to enter the contest, yet YOU may be the one to walk away with a cathode-ray oscillograph, volt-ohmmeter, service oscillators, de luxe set analyzer, vacuum-tube voltmeter, multimeter and three-reference-point tester, or one of a half-dozen of the thousand-page Consolidated Official Radio Service Manuals!

The contest opens on June 1, and closes Aug. 15, 1935.

Please mention SHORT WAVE CRAFT when writing advertisers

\$5.00 Prize

Novel Antenna Coupler

Being one of those fellows who strive to

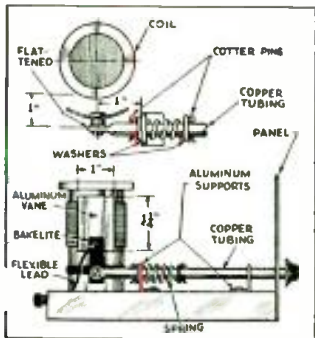

make a few tubes work as efficiently as possible. I find that the method of antenna coupling should be given considerable thought. Most of your "prize-winning kinks" worked very well, but they could not be easily operated from the front panel and were in the way when the coils were changed. With a couple of pieces of scrap aluminum and a short length of copper tubing, I made this antenna coupler which works very smoothly and is efficient. Not only is it a great help on the crowded bands as a selectivity-sensitivity control, but it "smooths out" the regeneration control. A smooth regeneration control is, in my opinion, the difference between a very FB receiver and just another squealer. The diagram is self-explanatory and the construction of this coupler should not be at all difficult. Be sure to use a flexible antenna lead to the vane. The length of the bakelite strip depends on the position of the tickler winding. This is the small winding that is invariably wound in the same position on each coil. The vane has no effect on this winding, so in an upright position the bottom of the vane should be above the tickler.—W. J. Kowalchik.

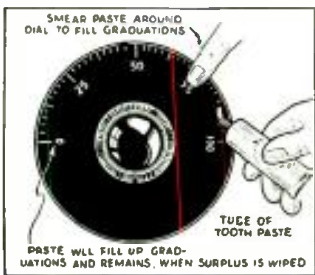

Touching Up Old Dials

This kink is not original with the writer, but he thinks it is worthy of passing on to the readers of SHORT WAVE CRAFT. The appearance of old dials can be improved considerably by taking a bit of white toothpaste, white lead, white candle wax on the end of one's fingers and smearing it around the edge of the dial as illustrated. The tooth paste will fill the notches on the dial. When the dial is wiped off with a rag, it will look as good as new.—Bob Miller.

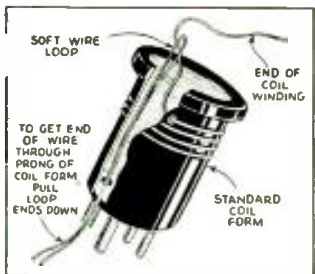

Coil Winding Kink

In winding plug-in coils, one is likely to have trouble in getting the end of the wire threaded through the prong. I take a piece of soft wire, double it, then push it up through the prong, put the end of the coil wire through the loop, then pull the doubled wire down through prong and the coil is threaded.—W. Chester Caselman.

\$5.00 FOR BEST SHORT-WAVE KINK

The Editor will award a five dollar prize each month for the best short-wave kink submitted by our readers. All other kinks accepted and published will be awarded eight months' subscription to SHORT WAVE CRAFT. Look over these "kinks" and they will give you some idea of what the editors are looking for. Send a typewritten or ink description, with sketch, of your favorite short-wave kink to the "Kink" Editor, SHORT WAVE CRAFT.

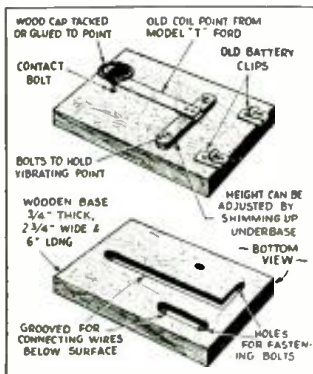

Home-Made Mike Stand

Here is an idea which should be gratefully received by the Ham with a flat pocketbook. The base is a large kong from an old doorbell, and it is mounted on a wooden embroidery hoop. Four spade screws are used to support the springs which hold the microphone. The diagram clearly shows how the complete assembly appears, and believe me, it surely is a sturdy stand and will hold the heaviest of microphones.—Lloyd Brown.

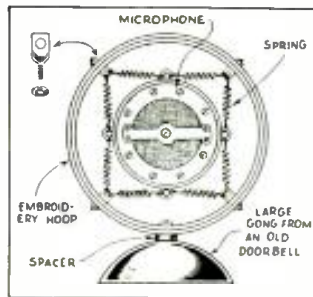

Emergency Key

Here's how to make a practice or "emergency" key. The key is made on a block of wood 6"x2 1/4", the vibrating point of an old Model-T Ford, together with the base of vibrator included. Some points have a hole near the contact point and some do not; it is best to use the former. Two screws are fastened through the base of vibrating point, the heads of which are countersunk in block.—William Brubaker.



Multiple Code Practice

Here is a scheme by which two-way code practice is possible using only one bell or buzzer. The .5 mf. condenser is used

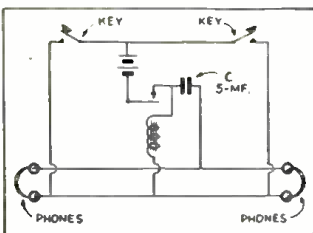

to keep the D.C. of the battery out of the phones. By connecting other keys and phones in parallel it is possible for more persons to practice at the same time.—Theodore Vega.



Handle for Plug-in Coils

The socket for the coils should be mounted 1/16" farther from the face of the panel than the length of the coil form, so that the pressure on the coils when being inserted will bring the shield plate in close contact with the panel. (Small machine screws can be used to fasten the handle to the top of the coil form and will be much stronger.—Editor.—E. Abbott.

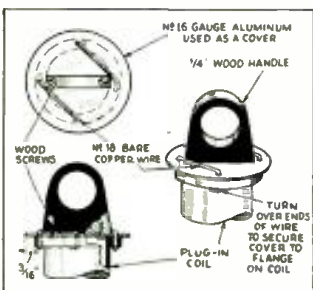

Improved Plug-In Coil

Here is a means of supporting the turns of a plug-in coil that provides for rigid and nonvarying turns.

With a triangular file, make notches in the ribs of a coil form so that they form a spiral. As most forms have eight ribs, the location of the notches can be easily calculated. If turns are spaced one quarter inch, file the notches on each successive rib 1/32" higher than the last. An interwound primary may be wound on smaller notches between the deeper ones.

If a tapped secondary is needed as in an electron-coupled detector, use tinned wire so the tap may be more easily located and soldered.—Stephen O. Edwards Jr.

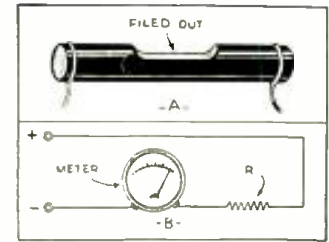
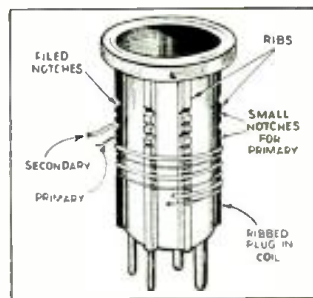

Substitute Grid-Clip

The other day I was in need of several grid clips. As it was Sunday, and I didn't have any on hand, I had to make my own.

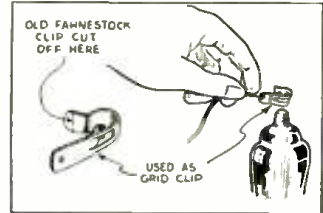

Here is how it is done in a jiffy. Just take an old Farnstock clip, spread it open enough to slip over the contact cap on top of the tube, next solder a wire to it, and you're all set. If it is too bulky, it can be bent until it is form-fitting with a lip which protrudes as shown in the illustration.—Ralph Netzel.



Antenna Trimmer Selector

Adjusting the antenna trimmer condenser every time a coil is changed is a lot of bother and may not always be the same, thus varying the dial settings. To overcome this, secure as many trimmer condensers as you have coils and place them on a bakelite panel. A switch arm

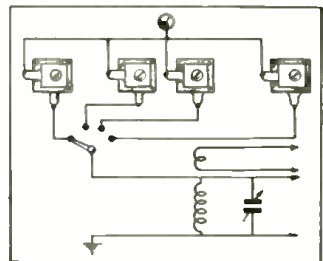

Multiple Headphone Connector

It is often desirable to connect more than one pair of phones to a set. An inexpensive and easily assembled connector can be made by connecting a 2-wire cable to a light socket. Then, insert a 3-way plug in the socket; fasten phone tips to attachment plugs, and plug in any number of headphones.—Wilbert Hohlender.

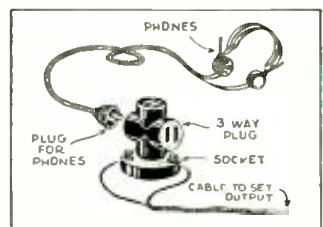

Increasing Meter Range

If you want to increase the range of your voltmeter it can easily be done with multiplying resistors. If the internal resistance "r" of the voltmeter is not known, have it tested. If the maximum reading is to be 10 times the scale reading, the total resistance (R+r) must be = 10 x r, or then R=9 x r. If the new maximum is to be 50 times the former reading, R=49 x r. Always R=(N-1) x r where N = new maximum, r = old maximum.

Now to make the resistors: just take a cheap carbon pictal resistor of slightly less resistance than is needed, with a curved-edge file, reduce the cross-sectional area of a portion of the resistor, until the resistance is increased to the exact size needed (as in Fig. A).—Robert Blaser.

Short Wave

UNTUNED R.F. AMPLIFIER

Linton Bylund, Cincinnati, Ohio

(Q) I would appreciate it very much if you would publish a diagram of an R.F.

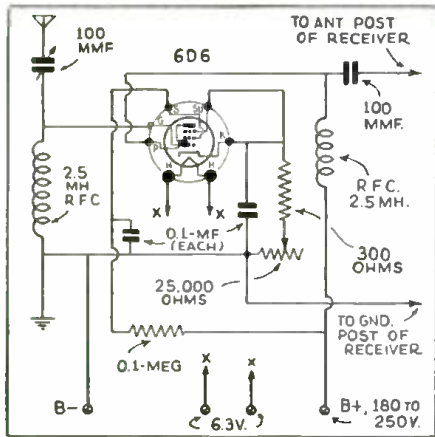

Diagram of untuned R.F. amplifier.

stage using a 6D6. I wish to add this to a 36 regenerative detector; I want this stage to be untuned.

(A) We take pleasure in printing the diagram of an untuned R.F. stage. While there is no appreciable gain in an untuned stage, it is of considerable advantage in that the detector is isolated more or less from the antenna and dead-spots are eliminated. If you wish to make this a tuned stage, it is only necessary to replace the R.F. choke with a regular plug-in coil and 140 mmf. condenser.

ANTENNA BLOCKS SUPER-REGENERATIVE DETECTOR

John Post, Flint, Mich.

(Q) I constructed the 2½- and 5-meter super-regenerator described in the November 1934 issue of SHORT WAVE CRAFT. When I attach an antenna to the grid circuit through the 6 mmf. condenser the detector goes out of oscillation. Could you tell me how this trouble could be overcome?

(A) Further experimentation with the 2-tube receiver showed that when the antenna is connected to the cathode of the tube a 25 mmf. condenser could be used in the antenna circuit and there will not be the least sign of blocking.

TUNABLE HUMS IN SHORT-WAVE RECEIVERS

M. McClough, Los Angeles, Calif.

(Q) I have built several short-wave receivers and I notice that there are several points on the dial at which a strong A.C. hum can be heard. This hum also breaks up the station which I am listening to, and I would like to know if it can be overcome.

(A) One of the most common remedies is the use of small by-pass condensers. A .002 mf. condenser should be connected from one side of the heater of your detector to the "B" negative. Also try connecting a .002 mf. condenser between one side of the high voltage winding of your transformer and the filament winding of the rectifier tube. In some cases it has been found necessary to use a condenser connected in this manner on each side of the high voltage secondary. Unused filament windings should have one side connected directly to the "B" negative.

POWER SUPPLY DIAGRAM

Kurt Sporre, Plainfield, N.J.

(Q) Please print in your Question Box a power supply using a 280 rectifier and one which will deliver 5 voltages ranging from 45 to 250 volts.

(A) The power supply diagram you requested is shown on this page and in order to get the various voltages, it is

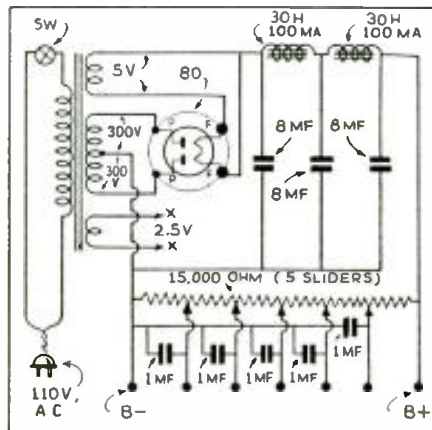

Power supply for short-wave receiver.

necessary to use a voltage divider with several taps or sliders. The best arrangement would be to use a 15,000-ohm

EDITED BY GEORGE

● Because the amount of work involved in the drawing of diagrams and the compilation of data, we are forced to charge 25c each for letters that are answered directly through the mail. This fee includes only hand-drawn schematic drawings. We cannot furnish "picture-layouts" or "full-sized" working drawings. Letters not accompanied by 25c will be answered in turn on this page. The 25c remit-

voltage divider with 5 sliders and with the aid of a voltmeter each slide can be adjusted to give the desired output.

AMPLIFIER HOWLS

D. Angelicola, Brooklyn, N.Y.

(Q) I added a 33 pentode to the 2-tube Doerle hook-up which was shown on page 611 in the Question Box of the February issue; I also added a 10-ohm rheostat. After it was completed and I tried to operate the receiver, I found that it was making a very high-pitched squeal which seemed to be due to the amplifier. Can you help me to overcome this difficulty?

(A) In most cases where pentode tubes have been added to receivers and an audio howl is experienced, it can be overcome by connecting a .006 mf. condenser to the B negative from the plate of the pentode. If this does not entirely overcome the trouble and resistance coupling is used, make sure that the grid resistor of the pentode is no more than 250,000 ohms.

OBTAINING BAND-SPREAD

Oscar H. Baker, Lawrence, Kans.

(Q) In the October issue of SHORT WAVE CRAFT you printed a circuit for a 3-tube A.C. set. I would like to know if I could use a Hammarlund MC-150-B band-spread condenser in this receiver in order to spread out the various amateur bands on the dial.

(A) The condenser you mentioned will serve very nicely in obtaining band-spread if you include some arrangement in the construction of your receiver for varying the tank capacity, that is the large section of the condenser, or this condenser can be set to nearly maximum capacity and the individual coils wound so that each amateur band falls in the center of the tuning range of the small condenser. Two separate condensers can also be used of course; a 140 mmf. condenser for the tank circuit, and a 20 mmf. condenser for band-spreading.

A.C. SET WITH 6.3 VOLT TUBES

C. P. Conley, W5E0U, Roby, Tex.

(Q) I intend to build up a short-wave receiver using the new 6.3 volt heater tubes. Would you be kind enough to print the diagram of a set that will pull in some real DX and one which can be constructed at a reasonable cost?

(A) It seems that the 6.3 volt heater tubes are becoming more popular every day and in the diagram which we have printed you will find a 6D6 tuned R.F. amplifier, a 6C6 regenerative detector with inductive coupling between the R.F. stage and the detector and a 76 audio amplifier. This set should give really good results if properly built and the parts are carefully placed. However, it will not work a loudspeaker and, in order to get speaker volume, it will be necessary to add another tube, preferably a 41 pentode.

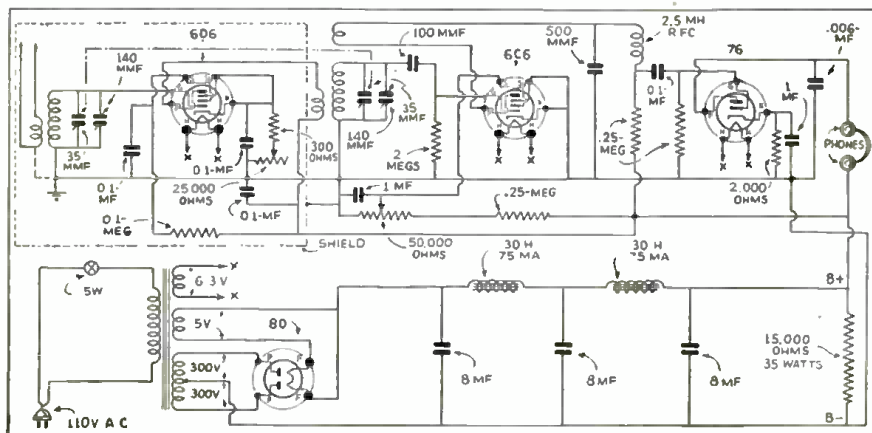

4-tube T.R.F. receiver using 6.3 volt tubes.

QUESTION BOX

W. SHUART, W2AMN

tance may be made in the form of stamps or coin.

Special problems involving considerable research will be quoted upon request. We cannot offer opinions as to the relative merits of commercial instruments.

Correspondents are requested to write or print their names and addresses clearly. Hundreds of letters remain unanswered because of incomplete or illegible addresses.

SELF-POWERED AMPLIFIER

Dick Schoel, Detroit, Mich.

(Q) I would like to have the diagram for a 12A7 rectifier and pentode audio amplifier. I would appreciate it very much if you would print this in a forthcoming Question Box.

(A) Building an audio amplifier and power supply around a 12A7 makes a really compact unit and can be added to almost any type of short-wave receiver. Those who are interested in experimenting may use this diagram which we have printed and construct a very compact audio amplifier which can be used in conjunction with small sets that they may build from time to time. In other words, it won't be necessary to construct the

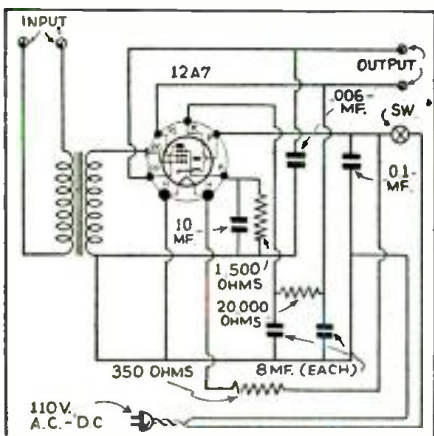

12A7 power supply and amplifier diagram.

whole set; just the R.F. portion can be built up and experimented with.

25-CYCLE FILTERS

"Megohm Box," London, Ont., Canada.

(Q) With reference to the 1-tube all-electric oscillodyne in the March issue of SHORT WAVE CRAFT I wish you would be more considerate of Canadian experimenters and give us some dope for 25-cycle power supplies inasmuch as most of us up here have this type of power service. I would like to know how we could construct this set and have it free of hum.

(A) Well, if you make the 1-tube oscillodyne a super-regenerative it is relatively simple to incorporate sufficient filtering to practically eliminate the hum, but if you are making the set a straight regenerative receiver, we would say that it would be practically impossible to eliminate all the hum in A.C.-D.C. circuits of this type, especially where the rectifiers and the detector are enclosed in a single glass envelope. It would seem that the capacities given would be sufficient for a super-regenerative circuit; however, if you have available some slightly larger condensers it would of course be advisable to use them.

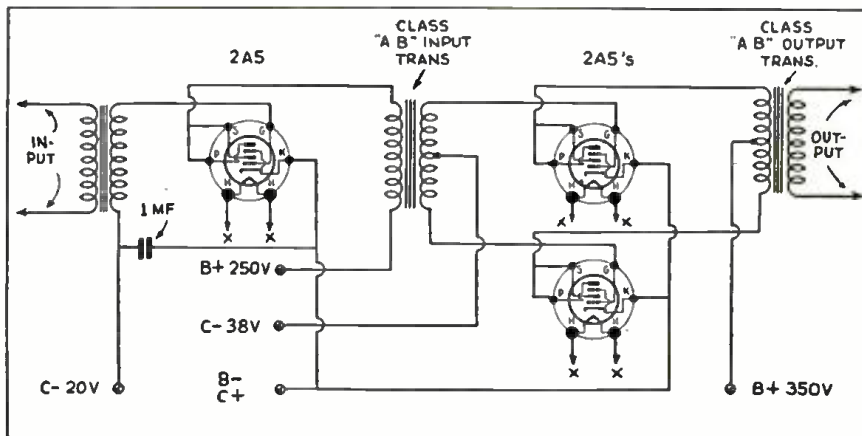

Class "AB" audio frequency amplifier, using type 2A5 tubes.

There is no simple manner in which the filter can be incorporated in 25-cycle half-wave supplies, unless you resort to resonant filters and so far, these have not been very successful in receiving sets. Furthermore, we think the fellows who are equipped with 25-cycle juicers should stay away from A.C.-D.C. circuits. They give enough trouble on 60-cycle supplies!

CLASS "AB" AMPLIFIER

A New Jersey Ham, New Jersey.

(Q) I am a constant reader of SHORT WAVE CRAFT and thought that you might be good enough to help me in constructing an audio amplifier or modulator for my 5-meter transmitter. Please show the connections for two 2A5's in class "AB" with 2A5 driver.

(A) We are showing your circuit and this should prove to be an ideal modulator for a low power 5-meter transmitter. Remember though, that the transformers must be designed for this particular purpose and regular push-pull transformers will not work satisfactorily. Also, if you are using a fairly low level microphone, it will be necessary to use another stage of amplification. A 56 could be used ahead of the 2A5 and would serve even for a very low level double-button carbon microphone.

ANTENNA TUNER

T. Allen, Bronx, N.Y.

(Q) In the article describing the antenna tuner on page 714 of the April issue, 350 mmf. tuning condensers are indicated in the diagram; in the Parts List 35 mmf. condensers are specified. Which should be used?

(A) The value shown in the diagram is correct, and these condensers are the midget broadcast type.

(Q) How is the two-turn pickup coil supported on the coil form?

(A) The two-turn pickup coil is wound in between the turns of the heavy wire.

4-TUBE A.C. SET

Thomas Restivo, Brooklyn, N.Y.

(Q) Would you please publish a diagram of a 4-tube A.C. receiver using a 58 tuned R.F. amplifier inductively coupled to a 57 regenerative detector with screen-grid regeneration control and a 47 resistance-coupled amplifier. The power supply should use an 80 rectifier.

(A) We are pleased to print your diagram, and this should make a very nice receiver. All the values are given and you should have no trouble in getting it to work. The coil data will be found in the April Question Box. When using an antenna and ground, the connection should be made where the dotted line is shown in the diagram; for doublet, the antenna coil is left free.

If you wish to gang the two 140 mmf. tuning condensers in order to have a single control receiver, it will then be necessary to connect a 50 mmf. condenser in parallel with the 140 mmf. tuning condenser in the R.F. stage. This is necessary in order to compensate for differences which may be caused by the antenna. The R.F. stage should be shielded as much as possible.

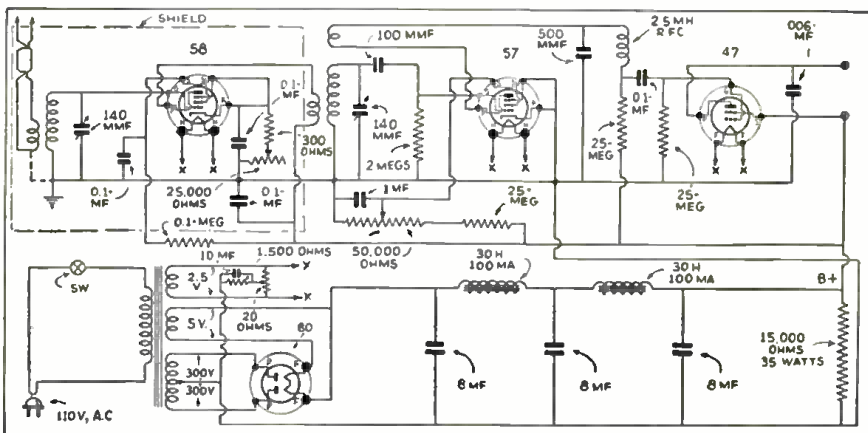

Complete A.C. short-wave receiver with 1 stage of T.R.F.

Short Wave SCOUT NEWS

Report From E. M. Heiser, Brecksville, Ohio

● THE 49-meter band is becoming noisy, although for a few evenings, reception was excellent on this band.

The 31-meter band is improving and some stations are coming in with tremendous volume.

A new station was heard testing for two evenings. The call was given as CHMB and the location, Cuba. The station came in loud, but was rather distorted.

A station was also heard just above FYA on 25.6 meters, but the call could not be identified. This is a Spanish-speaking station located in South America. It was heard for several evenings, but came in weak.

The 16- and 19-meter bands have been very poor.

FYA on 25.6 meters has been coming in the loudest they have ever been heard here, during the evening.

There seems to be less activity on the short waves at present than previously.

I am enclosing a detailed "log" for this period.—Edward M. Heiser.

Date	Time	Call	W. I.	Location	Remarks
Mar. 27	7:10	GSA, DJC, YV5RMO, HJ1ABB			All Loud, Some Static
31	7:35	YV6RV	48.91	Valencia, Ven.	Very Loud
31	7:50	CJRO	48.78	Winnipeg, Can.	Very Loud Bad Hums
Apr 3	7:40	GSA	49.59	Davenport, Eng.	Very, Very Loud and Clear
3	7:50	YV6RV	46.01	Valencia, Ven.	Very Good
3	8:10	GRC	31.32	Davenport, Eng.	Exceptionally Loud and Clear
4	7:15	CMHB	29.4	Cuba	Test Program, Int at 7:40 p.m.
4	7:20	EAQ	30.40	Madrid, Spain	Very Loud and Clear
4	7:25	GSA	49.59	Davenport, Eng.	Loud and Clear
6	3:00	FYA	25.6	Paris, France	Fair, Faded
6	3:10	GSD	25.6	Davenport, Eng.	Very Loud and Steady
6	6:50	GAC	31.32	Davenport, Eng.	Very Loud, Some Static
6	7:05	EAQ	31.40	Madrid, Spain	Fair
6	7:10	DJA	31.38	Zeesen, Ger.	Very, Very Loud
6	7:15	W2XAF	31.48	Sehegenradly, N. Y.	Fair
6	7:35	GSA	49.59	Davenport, Eng.	Very Loud and Clear
6	7:40	DJC	49.83	Zeesen, Ger.	Very Loud and Clear
6	7:45	HJ1ABB	46.53	Barquilha, Col.	Weak
7	9:50	WNC	19.92	Hialeah, Fla.	Workint HPF and YNA
7	7:25	GSD	25.53	Davenport, Eng.	Loud, but Noisy
7	6:45	FYA	25.6	Paris, France	Very Loud
7	6:50	CJRX	25.6	Winnipeg, Can.	Loud, but Distorted
7	6:55	GRC	31.32	Davenport, Eng.	Very, Very Loud and Clear
7	7:05	DJA	31.38	Zeesen, Ger.	Very Loud
7	7:40	GSA	49.59	Davenport, Eng.	Very Loud and Clear
7	7:45	DJC	49.83	Zeesen, Ger.	Very Loud, but Heter Whistle
8	7:10	KKP	18.25	Kohuku, Hawaii	Fair
8	7:20	EAQ	30.40	Madrid, Spain	Very Loud and Clear
8	7:25	GSC	31.32	Davenport, Eng.	Loud, but Faded First
10	7:15	W2XAF, W1XX, W3XAU	31		Very Loud, Europe Could Not Be Heard. On 49 M. Europe Could Not Be Heard, U.S. and S. A. Very Loud
10	7:25	ZFA	59.7	Hamilton, Ber.	Working WOB
11-12	8:45	FYA	25.6	Paris, France	All Bands Very Poor Just Undergradtable
13	7:00				41 and 49 M. Bands Very Noisy
14	6:50	WNC	19.92	Hialeah, Fla.	Working HPF
14	10:40	HJ1B	20.07	Bogota, Col.	Working WNC
15	8:00	LSX	30.07	Buenos Aires, Arg	Very Loud
15	8:20	COH	31.8	Havana, Cuba	Very Loud, Code Interference
15	8:30	DJA	31.38	Zeesen, Ger.	Weak
15	8:35	KKP	18.25	Kohuku Hawaii	Fair
15	8:50		31.13		Announced "Roma National Hour"
18	7:15	FYA	25.6	Paris, France	Very Loud and Clear
18	7:20	EAQ	30.40	Madrid, Spain	Loud, but Fuzzy
18	7:25	GSC	31.32	Davenport, Eng.	Loud, but Faded
18	7:30	GSB	31.55	Davenport, Eng.	Loud, but Faded
19	7:40	DJA	31.38	Zeesen, Ger.	Just Undergradtable
20	7:00	KKZ	25.6	Paris, France	Loud, but Faded
20	7:10	FYA	25.6	Paris, France	Very Loud and Clear
20	7:20	DJA	31.38	Zeesen, Ger.	Very Loud and Steady
20	7:25	DJA	31.45	Zeesen, Ger.	Louder Than DJA
20	7:35	GCB	31.55	Davenport, Eng.	Very, Very Loud and Clear

Report From Oliver Amlie, Phila., Pa.

● ALL readers of SHORT WAVE CRAFT are cordially invited to hear a world-wide broadcast given by this post over WCAU-W3XAU Philadelphia, Pa., U.S.A. stations. Time cannot be given here, as I will receive my allotted time on the air later from WCAU-W3XAU, which will be too late for publication in this column, therefore, my advice is this, you will have to listen in from first of October 1935 to the 17th each evening from 6-7:30 p.m. on the 31-meter band of W3XAU, and WCAU broadcast band; this broadcast is a gift from WCAU for the good work this post has done and

still continues to do for the Australian Government. When you hear SHORT WAVE CRAFT mentioned in my broadcast to Australia, you will know it is Trophy Winner No. 10 speaking.

The Australian reports now stand at 120 from October 1934 to April 1935. Some people think it is hard to hold one Australian station; others think holding two Australian stations at one time is hard. Ever try holding three? This happened Apr. 12 from 6:30 to 7:00 a.m. when W2XAF was testing with VK2ME and

3ME-3LR was being held by this post; like a flash I also grabbed 2ME holding the three at one time. Try it—it is easy if you have a good receiver. Forty-three reports on 2ME-3ME-3LR were received for March alone, and on 27 mornings holding two stations each morning from Australia, and getting up at 5 a.m. for 25 mornings a month for one year. It's enuf.

Spent an hour with the amateurs; would appreciate a QSL card from any amateur whose call letters are below, will answer all replies.

March 19, 1935. 19-20 meter band. 5-5:35 p. m.

W9BEC HCCP VE3DB W9PEG W5PP W8IO W9CPM CO2HY W9GHY W4HG W9SBV
W1ATI W9KDP W9SBD W9PGA W1EP W4AQ W8ZME W9HGO W9HVJ W1AHI W3BEE
W1HO W5CCE W5CLO W9CVM W5XXV W9BT W9PBO

April 7, 1935. 8:20-8:50 p. m. 19-20 meters.

W2DDW W5WT W3AEB W3IT W7AFX 6JEF W2DYR 3H5BL 2AHX
KPY W9DMF W3BBO W6AMB W5FT G5ML W8BLD 2BG W1HK

April 7, 1935. 8:50-9:05 p. m. 80-meter band.

W9DDU W2AO WCRK W2BL W3SL W1AVP W2AXV W9TM W3BWZ
W8XAM W3ADL Bad weather this eve

April 7, 1935. 10-10:25 p. m. 160-180 meters.

W2XAF W1WC W3AMD W3AIQ W3AWL W3GNY
Veries received KEW-KEE-HAS3-12RO-1CJ-YV5RMO-VI3AS.

—Oliver Amlie.

Latest "Hot" Tips for Short-Wave Listeners from our "OFFICIAL LISTENING POSTS"

Report From New York City

● STATIONS heard and logged this month are: GSA, GSB, GSD, GSC, GSE, GSF, GSG, GSL, DJA, DJB, DJC, DJD, DJN, DJJ, DJE, FYA—19 meters. FYA 25.6 meters—PCJ 19 meters—PHI 25 meters—HAS3 19 meters—HAT4 33.2 meters—RNE 25 meters—CT1AA 31.25 meters—CT1AA 49.4 meters—CT1GO 21.2 meters—CT1GO 48.4 meters—HVJ 19.8 meters—ZFB 29 meters.
FVM 27.9 meters—VK2ME-VK5ME-VK3LR-RV15 70.6 meters—JB 49.1 meters. COC-COH-PRF5-H11A 48.4 meters—YV2RC-YV3RC-YV4RC-YV6RV 46 meters—YV5RMO-HCJB 36.5 meters—TIEP 45 meters—TIGPH 51.5 meters—HP5B 49.75 meters—XEBT-YN-1CG 46.9 meters—CSL 48.7 meters—2:30 to 6:00 p.m., E.S.T.
HJ1ABB-HJ5ABC 42.7 meters—HJ4ABA 25.6 meters—HJ1ABD 41.2 meters—HJ1ABE 49 meters—HJ3ABH 49.9 meters—HJ4ABE 50.6 meters—HJ3ABD-HJ4ABB 42 meters—HJ5ABD 46.2 meters—HJ1ABC 49.65 meters—HJ4ABL 49.1 meters—HJ1ABJ 49.6 meters.

HC2RL-PRADO-HIX 50.1 meters—HC2ET 63 meters—CO9GC, P.O. Box 137, Santiago de Cuba on 48.7 meters—HI4D 46.2 meters—OAX4B 48 meters—OAX4D 52.8 meters—VE9GW 49 meters. CJRX-CJRO-W8XK on 19-25-49 meters—W2XE 19-25-49 meters—W3XAL 16-49 meters—W1XX 31 meters—W1XAL 49 meters—W8XAL 49 meters—W9XAA 49 meters—W9XF 49 meters. W2XBS 2800 kc., Bellmore, N.Y., Experimental W4XB 49.7 meters.

Several unidentified stations have been heard.

Verifications received are as follows:—TIGPH-5823 kc. "Alma-Tica," San Jose, Costa Rica; HJ3ABH-6012 kc. 250 watts, "La Voz de la Victor." Apartado, Postal

565, Bogota, Col., S.A.; HJ1ABD, Cartagena, Col., S.A., 41.2 meters—100 watts, formerly 49.2 meters.

Booklet received from B.B.C. Veri from: PRF5 and HJ5ABC on 42.7 meters, Cali, Col., S.A.—50 watts, La Voz De Colombia—on Mondays, Tuesdays, Wednesdays, Fridays—7:00 to 9:30 p.m., E.S.T. HAS3 19.5 meters—HAT 55.5 meters—HAT4 32 meters—HP5B-CT1GO 24.2 meters—CT1GO 48.4 meters.

31-meter band has been very strong here lately; 49-meter band good but noisy; 16-meter band is getting stronger; 25-meter and 19-meter bands changeable.—John Sorensen, 3301 Waterbury Ave., Bronx, N.Y.

Sinking Springs, Pa., Report by Geo. D. Sallade

● HOW many fans heard the remarkable broadcasts of SUV and SUX during the week of Apr. 3? To hear a voice from the Shadows of the Sphinx and Pyramids say "This is SUV and SUX, Cairo calling" gave me the outstanding thrill of the year!

I suppose many fans are still in a state of phantasmagoria from that broadcast, which was R9 on both stations. SUV used a frequency of 10055 kc., and SUX, 7860 kc.

For those fans who are interested in confirmations, I print this letter, which was received from Cairo:

Dear Sir:

We thank you for your letter reporting reception of our station SUV (10,055 kc.) and confirm transmission.

We are relaying a broadcast for the benefit of the U.S.A.

Yours faithfully,
Marconi Radio Telegraph Co., of Egypt.,
Radio House, Sharia, Eloui,
P.O. Box 795, Cairo, Egypt.

There is a new station CMHB, broadcasting in Sancti Spiritus, Cuba. The frequency of this station is 10,200 kc. The address is P.O. Box 85, Sancti Spiritus, Cuba.

HCJB, La Voz de Andes, in Quito, Ecuador, is now using a frequency of 8,200 kc. They can be heard almost nightly. The British Broadcasting Corporation is now sending pictures of the Broadcasting House, London. These cards which replace the "courtesy cards" are worth while having. They also include a schedule, for all transmissions until Aug. 31. The above data (Continued on page 182)

2-Channel S-W Receiver Picks Up Two Programs at Once

(Continued from page 139)

it will carry the current drawn by the 19 detector and audio stage. The three tube section with the 33 output tube, works well into a magnetic speaker without the use of an output transformer. It is necessary though, that the plates of the output tubes be by-passed with .006 mf. condensers for maximum stability.

The Dual-Channel receiver is built on an electrical chassis, measuring 7x10x2½ inches deep and the panel is 7 inches high and 10 inches long. On the left of the panel is located the tuning condenser for the 2-tube set. And right under the tuning dial is located the regeneration control. On the right side of the panel are the tuning and the regeneration controls of the 3-tube section. Separate antenna condensers are and have to be used, although a single antenna will work just as well as two separate antennas one for each section.

Use the same or nearly the same layout as the original set if a minimum of interference between the two sections is to be maintained! The first 19 tube which serves as the detector and audio stage of the 2 tube section is located directly between the two tuning condensers. The 19 which serves as the other detector and audio stage is mounted directly behind the coil and the 33 is located in the center of the base toward the rear edge.

During tests this receiver combination worked very nicely with 90 volts on the plates and there seemed to be no advantage in using 135 volts. The filaments are shown connected in parallel and require 2 volts, which can be furnished by four No. 6 type dry cells, connected in series-parallel. An alternative would be to connect the filaments in series and apply 6 volts from four dry cells connected in series also; or operate them from a 6-volt storage battery. With the filaments connected in series no rheostat is needed. A 10-ohm variable rheostat should be used to drop the 3 volts to 2, when the filaments are connected in parallel. Many interesting stunts can be performed with this receiver as tests have shown and no doubt the experimenter will pass many interesting hours with it.

Parts List for Dual-Channel Receiver

- 4—140 mmf. variable condensers, Hammarlund, Na-Ald.
- 2—35 mmf. antenna tuners, ICA.
- 2—.006 mf. by-pass condensers, Sprague.
- 3—.1 mf. by-pass condensers, Sprague.
- 1—.25 mf. by-pass condensers, Sprague.
- 1—A.F. choke (see text).
- 3—50,000-ohm 1-watt resistors, IRC (Lynch).
- 3—¼ megohm ½-watt resistors, IRC (Lynch).
- 2—2 megohm ½-watt resistors, IRC (Lynch).
- 2—6-prong wafer sockets, Na-Ald.
- 1—5-prong wafer socket, Na-Ald.
- 2—4-prong Isolantite sockets, Hammarlund.
- 2—phone strips, ICA.
- 1—chassis (see text), ICA.
- 2—3-inch National dials.
- 1—Pair headphones (2,000 ohms), Cannon-Ball (Trimm).
- 1—magnetic speaker, any good make.
- 2—45 Volt "B" batteries, Burgess.
- 4—No. 6. dry cells, Burgess.
- set coils 15-550 meters, Na-Ald.
- 19 tubes, RCA Radiotrons.
- 33 tube, RCA Radiotrons.

Na-Ald. Plug-in Coil Data

Meter Wave-length	Grid coil turns	Tickler turns	Distance Between 2 coils
200-80	52 T. No. 28 En. Wound 32 T. per inch.	19 T. No. 30 En. Close wound (C'W)	¼"
80-40	23 T. No. 28 En. Wound 16 T. per inch.	11 T. No. 30 En. C. W.	¼"
40-20	11 T. No. 28 En. 3-32" between turns	9 T. No. 30 En. C. W.	¼"
20-10	5 T. No. 28 En. 3-16" between turns	7 T. No. 30 En. C. W.	¼"

Coilform—2¼" long by 1¼" dia. 4-pin base.

Broadcast Coils

Tickler—28 turns No. 34 enameled wire. Grid—126 turns No. 28 enameled wire. Space between tickler and grid coils ¼ inch. All windings close wound on a 1½-inch diameter form.

Just Call Me Little Ajax

I defy the static. And any other interfering noises. Let 'em all come—whirrs, buzzes, screeches, man-made or other noises—anything that chafes your eardrums—I'll keep them out of your set!

PERFECT EUROPEAN RECEPTION!

Muter has met your doublet antenna problem—and solved it—with this new tuning device. It will couple a doublet antenna to your set—or any set—and it has switch control! This adapts it to all wave-lengths by a mere turn of the switch. The three taps adjust the antenna for QUIET European reception, efficient broadcast reception, or the sharpest possible tuning on any band. Think of the convenience! No need to disconnect wires. Just turn the switch. Any antenna but a doublet is obsolete—and any doublet without "Little Ajax" is just another aerial! With this coupler, your set will develop new tonal excellence and a quickened responsiveness. In addition to an unheard of fidelity and resonance, you will find your set increasing in efficiency and volume. More important than the improved reception, this coupler resists outside and man-made interference! It reduces static to an absolute minimum.

Get one from your jobber—or mail the coupon NOW and this All-Wave Tuning Coupler will be sent to you at once, postage paid. Just pay the postman \$1.00 when it arrives. And, of course, it takes out all your reception troubles or your dollar will be immediately refunded.

Complete instructions for making the perfect doublet antenna system and attaching this coupler are included.



THE MUTER COMPANY
1255G So. Michigan Ave.
CHICAGO, ILLINOIS,
U. S. A.

MAIL THIS COUPON!

THE MUTER COMPANY
1255G South Michigan Ave.
Chicago, Illinois.
Please RUSH me one of your All-Wave Tuning Couplers. I will pay the postman \$1.00. It must satisfy me in every way.

Name

Address

City State

THE SKLAR "AIRKOR" CONVERTER



This is a new type A.C.-D.C. self powered short-wave converter. It is designed and built on radically new engineering lines. Two tubes: one 6A7 and one 37 are used. Single dial tuning, using 2-Rank condenser, 8 turnless "AIRKOR" Coils covering a range from 16 to 210 meters. Leatherette covered case as illustrated.

With a 10-foot inside aerial 50 European and South America stations were received with local volume, on the loud speaker.

Sold in Kit Form, containing all parts, including 8 coils, blue prints and engineering instructions. Price per kit, to service men and experimenters.....

Wired and tested, \$1.50 extra. Leatherette covered case..... \$1.25

Set of 4 "AIRKOR" formless coils, 4 prong, 16 to 210 meters, can be used in many short-wave circuits..... \$2.10 net per set.

Write for free circular.

Louis B. Sklar Eng. Co.
816 North Sixth Street
Philadelphia, Pa.

Small deposit required on all orders

\$9.25
Less tubes

READ SEND CODE Like an Expert

Learn Quickly at Home—Get Real SPEED

It's easy, fascinating, to become a good op with the New MASTER TELEPLEX Code Teacher to help you. Only instrument ever produced which records your sending in visible dots and dashes on copper tapes—then sends back to you. Also sends practice work, recorded by an expert, at any speed you want. Thousands agree this method is surest, quickest—has taught more ops in past few years than all other methods combined. Used by U. S. Army, Navy, A. T. & T., R. C. A., and others. We furnish Complete Course, lend you Master Teleplex, give you personal instruction with a MONEY-BACK GUARANTEE. Low cost. Send today for booklet \$31; no obligation; post card FREE BOOK will do.



TELEPLEX COMPANY
78 Cordand St.
New York, N. Y.

MASTER TELEPLEX—"The Choice of Those Who Know"

Please mention SHORT WAVE CRAFT when writing advertisers

SHORT WAVE LEAGUE



HONORARY MEMBERS

Dr. Lee de Forest
John L. Reinartz
D. E. Replogle
Hollis Baird
E. T. Somerset
Baron Manfred von Ardenne
Hugo Gernsback
Executive Secretary

A Good Anti-Code Test Argument

Editor, SHORT WAVE CRAFT:

● I HAVE been listening in on your "No-Code-Test"* argument for quite some time and would like to make a few observations.

I am a college graduate and consider myself slightly better than a moron, and yet in the fourteen years I have been experimenting with radio I have not found the time or energy to learn the code. Should I be able to transmit, it is almost certain that 95 percent of my time would still be spent in *circuit experimentation* and not in the silly conversations that I have heard on the air. The amount of money I have been able to spend on my hobby has been so small, that I have had to rely mainly on my engineering training to put sets together that would work at all, and consequently have spent as many happy hours "just figuring," as have the most of these brilliant amateurs who have been *cluttering up the air*.

Another interesting angle in this argument is, that I find that the greatest percentage of those in favor of a *code test* are strangely affected by the type of infantile invective that has recently overrun the broadcast band. Words, no matter how bad they are, never constitute an argument. There must be some facts to be weighed, or else the *code test* is absolutely useless, unfair, and should come under the *nuisance laws*.

KENNETH F. WICKS,
367-95th St.,
Brooklyn, N.Y.

*This refers to the argument originally advanced by the Editor that, to popularize the 5-meter band and make it more easily available for the use of the short-wave experimenter in general, no code test should be demanded by the Government.

Get Your Button

The illustration herewith shows the beautiful design of the "Official" Short Wave League button, which is available to everyone who becomes a member of the Short Wave League.

The requirements for joining the League are explained in a booklet, copies of which will be mailed upon request. The button measures $\frac{3}{4}$ inch in diameter and is inlaid in enamel—3 colors—red, white, and blue.



Please note that you can order your button AT ONCE—SHORT WAVE LEAGUE supplies it at cost, the price, including the mailing, being 35 cents. A solid gold button is furnished for \$2.00 prepaid. Address all communications to SHORT WAVE LEAGUE, 99-101 Hudson St., New York.

Asks for Vote on the "No-Code" License

Editor, SHORT WAVE CRAFT:

● I READ SHORT WAVE

CRAFT from cover to cover including all of the letters printed about the no-code test below 5 meters. The question has been at issue so long that a definite step must be taken before the hopeful would-be Hams (codeless) get gray hair worrying over it. There are so many Hams and others interested that it surprises me that no steps have been taken so far.

We must act in a body if we wish to accomplish anything worth while. I'm not sure just what steps should be taken first but a vote on the issue should be taken. I am sure that the Editor of SHORT WAVE CRAFT would consent to act as executive of this poll.

If such a step is taken a coupon or postcard could be printed in SHORT WAVE CRAFT (perhaps in other Gernsback publications, too) to be clipped out and sent to the Editor with the answer.

In this way all the voters would have to buy a magazine to vote. I hope you consider this plan; I'm sure that it will benefit the magazine as well as the ones interested in this 5-meter phone test.

Another possible way to help pay the Editor to try this voting is to have all voters join the *Short Wave League*; they ought to anyway.

After the vote has been taken the Federal Communications Commission could be notified as to the result and asked to act on it. All I ask for is *fair play* and hope that all the others who are interested in this will play fair with me. Let's not write any back-biting letters, either pro or con. Wait and see what your leader the Editor will do. If my plan doesn't hold water, the Editor might try to iron out some of the wrinkles.

MEL HAGEN,
326 Eden St.,
Lodi, Calif.

Learn the Code, Says He

Editor, SHORT WAVE CRAFT:

● I HAVE been reading all these different letters from Hams and short-wave fans who are arguing about something which will do not a bit of good, only waste some good space in your magazine, so as long as it is being done I am offering my humble opinion, which will waste a little more space.

I guess the argument is about whether



Short Wave League

At a Directors Meeting held in New York City, New York, in the United States of America, the Short Wave League has elected

John F. Müller

a member of this League.

In Witness whereof, this certificate has been officially signed and presented to the above

H. Winfield Secor
Club Secretary

This is the handsome certificate that is presented FREE to all members of the SHORT WAVE LEAGUE. The full size is $7\frac{1}{4}$ " x $9\frac{1}{2}$ ".

See page 190 how to obtain certificate.

or not we should have a code test to get a license for phone work below six meters. It is really hard sometimes to know just what these fellows are beefing about as their letters are all cluttered up with clever insults to each other.

As far as I can see no one is getting ar where and I don't think anybody will, why not cut it all out and save our tir. and trouble and breath. It has been decided by the Federal Communications Commission that no one will be granted a license until he has met their code requirement and I don't think they will bother to do a thing about remodeling this law even if SHORT WAVE CRAFT allowed all the pages in their magazine to be filled with protests.

It is interesting to note that most of the protests come from short-wave fans, who haven't got a start in Ham radio yet, or from ex-Hams who, I suppose, got disgusted with the game and are trying to put silly ideas in the heads of these fans, who I think would make a fine bunch of Hams if they'd give themselves a chance. There are also a few protests from Hams with very recent calls and ten to one I bet they had

(Continued on page 183)

First Award in Our \$5.00 "YL" Station Photo Contest

(Continued from page 145)

light brown hair, (long), gray-green eyes, height 5' 4", weight 103. Occupation: bookkeeper for chain of shoe stores. Hobby and life interest: ham radio.

FACTS ABOUT W9CMV STATION: Code learned through "skeds" with W9FLQ (now 9NNR) of Kansas City, Mo., by listening on receiver for short messages three times a day. Started in with code in October 1931; put first "rig" on the air Dec. 25, 1931, with temporary license, using TNT with pair of '45's, push-pull. Took exam in May 1932, in Pittsburgh. Worked 80 meters exclusively till Oct. 5, 1933. All districts and Porto Rico worked.

Attended five conventions: Midwest Division at Topeka, Okla.; State at Tulsa, Okla.; State at Ponca City, Okla.; Midwest Division at St. Louis; State at Kansas City, Mo. Member of Royal Order of Wouff Hong.

(Miss) Opal Sisk,
(W9CMV.)
Pittsburg, Kans.

Miss C. G. Lyman, W2IEM.

● THE photograph shows the writer, W2IEM, operating the transmitters of the Harlem Radio Club, W2ESK, located at 180 West 135 St., New York City, of which I am a member. I hope this photograph will be acceptable for entry in your "YL" Photo Contest.

I received my call a short time ago, but my activity on the air has been limited to working some of the club members in the neighborhood. I am handicapped by living in a 110 volt D.C. neighborhood. My transmitter is a push-pull M.O.P.A. arrangement, using 43's as a TNT push-pull oscillator, capacity-coupled to 48's push-pull final amplifier. The antenna is a half-wave current-feed Zepp for 40 meters. My receiver is a 2-tube regenerative detector and audio using 30's.

I do the major part of my operating at W2ESK, which is on 3557 kc., 7008 kc., and 14016 kc., using my personal sign of "Gen" under the club's call letters. I am interested mainly in DX and its possibilities on 20 and 40 meters. I would like to go on phone, but that is impossible at present.

I became interested in amateur radio about 16 months ago, when I saw a radio exhibit given by the Harlem Radio Club at the Y.M.C.A. They allowed me to speak over the mike to another station some distance away, and what a thrill that was! Immediately, I joined the club, and started to study with the aid of some of the members, until I took the examination and received my license last March 2. I am a student of Hunter College, living with my parents. My other pastimes are music and tennis.

Hoping to QSO you, CUL and 73,
(Miss) C. Geneva Lyman,
1945 Seventh Ave., New York, N.Y.

New Dry Electrolytic Condensers

● IN the past few years electrolytic condensers have become very popular in the construction of radio receivers, inasmuch as a great amount of capacity can be obtained with a fairly small unit. These new electrolytic condensers differ considerably from the average in that the electrolyte consists of a single chemical and not a mixture of several. Consequently, there is no tendency during the manufacture or life of the condenser for the parts to separate, this new feature resulting in practically no change in the characteristics of the condenser.

They have a peak voltage of 550 volts and a normal working voltage of approximately 500, together with a very low leakage current. Refer to No. 287.

THE EILEN 5A RECEIVER



6D6-6D6-76-12A7 Tubes—A Masterpiece in Design

Uses 4 of the latest hi-gain tubes, 6D6-6D6-76-12A7 (dual-purpose tube) in special circuit as RF amplifier, screen-grid regenerative detector, triode audio amplifier, power pentode amplifier, rectifier & built-in power supply.

- * 5 tube performance
- * Illuminated airplane vernier dial
- * BANO-SPREAD tuning
- * Great VOLUME-Power plus.
- * An excellent "OX" receiver for the long-distance fan.
- * Large 3 winding coils
- * Built to the famous EILEN standard of quality.
- * Selectivity & volume control.
- * Operates on 110 V ac or dc house lighting circuit.
- * Makes a powerful amateur station receiver.
- * Operates a speaker on many stations.
- * Covers approximately 10-600 meters.
- * SOLD ON A MONEY BACK GUARANTEE—YOU MUST BE SATISFIED.

Beautiful, heavy black shrivel finish metal chassis & cabinet. Must be seen to be appreciated. Coils for 10-200 meters & instructions included. ORDER YOURS TODAY.

KIT, assembled and ready to wire
Matched Arcturus tubes..... \$2.65
Beautiful metal cabinet, binged lid. 1.25
Broadcast band coils (2)..... 1.25
\$7.45

SPECIAL, complete kit, tubes, cabinet, & BC coils..... \$11.45
Wired & tested, ready to use, add..... 1.35

EILEN HG-35 RECEIVER



A CUSTOM-BUILT, high quality receiver designed so as to give regular broadcast receiver volume on LONG DISTANCE under good conditions. Uses 2 "high-gain" tubes, 6B-35-56-2A5-84 types in special circuit producing REAL RESULTS.

- * Covers 10-600 meters
- * Built-in dynamic speaker
- * Illuminated airplane dial
- * Operates on AC house lighting current
- * Band-spread tuning
- * Headphone jack
- * Built-in power supply

RECEIVER, ready to wire
Matched Arcturus tubes..... \$2.95
Cabinet..... 1.00
Broadcast coils (2)..... \$1.45
Wired & tested..... 2.00
SPECIAL: Complete, ready to use..... \$18.95

CIRCUIT-1-TIS

"The answer to the SW experimenter's prayer"
COMPLETE KIT of all parts required to build any and ALL of the following receiver circuits:
20 single tube battery set
19 "Twin" 2 in 1 circuit battery set.
30 and 33 pentode battery set.
20 and 30 and 33 pentode battery set.
12A7 "Twin" AC-DC electric set (2 in 1)
7B-12A7 AC-DC electric set (3 in 2)
7B-76-1V AC-DC electric set
Simple diagrams and instructions, SW coils, chassis, panel, sockets, condensers, resistors, dials, etc. are all included. NOTHING else to buy except tubes. Highest quality apparatus backed by the Eilen name.
KIT of parts..... \$1.00
Cabinet for above..... \$1.25
Broadcast coils..... \$1.25
Wired for any of the above circuits, extra..... \$1.25
\$4.75

\$1.00 deposit on COD orders. 24 hour service. Stamp for receiver catalogue

EILEN RADIO LABORATORIES, Dept. SC7, 136 Liberty St., New York, N. Y.
(The Standard of quality)

THE ALL-ELECTRIC RECEIVER

Greatest Value on The Market

4 tube PERFORMANCE from 3 tubes 6F7-76-12Z3

OWNERS REPORT RECEPTION OF AS HIGH AS 35 FOREIGN COUNTRIES



Mr. A. W. Turner of Baltimore, Md. writes: "pulled in 3 English BC stations in less than 20 minutes, two of them with sufficient audibility to work a magnetic speaker... code points in loud & clear."

Functions as screen-grid reg. detector, 2 stage audio amplifier, rectifier & power supply. Simply plug into electric light socket & operate. Beautiful black shrivel metal chassis & panel. Coils for 10-200 meters & instructions included.

KIT, assembled & ready to wire..... \$1.25
Wired & tested..... 2.25
Arcturus tubes..... 2.25
Broadcast coils (2)..... 1.25
Beautiful cabinet..... 1.10
SPECIAL: Complete, ready to use @..... \$10.95

SPECIAL: Arcturus Radio Tubes 6 months guarantee

30	\$0.39	45	.54
19	.57	46	.55
33	.56	47	.55
12A7	.62	50	1.35
7B	.55	1V	.52
7B	.39	210	1.17
80	.30	Magnetic speaker	\$1.30
83	.40	Canonball phones	1.25

AMATEURS: Send 5 cents in stamps for illustrated bulletin No. TN-1 of SW TRANSMITTERS. (xtal controlled & self-excited), monitors, & accessories.

FREE Just Released!

IMPORTANT BUYING GUIDE

For Radio Servicemen, Dealers, Experimenters and Short-Wave Fans. Supplement Catalog No. 29, 1935, Spring-Summer Edition

Lowest Prices—This Book Will Save You Money
32 Pages — Two Colors — Profusely Illustrated

Packed between the covers of this new book is a huge array of modern radio equipment and other electrical and scientific merchandise—perhaps the very material for which you have been looking—and at prices which cannot possibly be any lower. A truly important buying guide for radio servicemen, experimenters, dealers, short-wave fans, biological and optical students, and other men following scientific professions.

Contains all-wave radio receivers, automobile sets, low-priced microscopes, field glasses, complete public address systems, Official Doerle and other short-wave receivers, crystal radios, radio replacement parts and accessories, latest testing instruments, etc. NAME THE ITEM AND IT'S IN THE BOOK.

You can increase the value of your dollar by buying at the low prices contained in this buying guide. This amazing book will show you how to save money by buying economically. Why not start saving now? Don't delay. Write today for your free copy. You are not obligated in any way.

WRITE TODAY—send postcard or letter. Buying guide sent by return mail. IT'S ABSOLUTELY FREE.

RADIO TRADING CO.

101A Hudson St. New York, N. Y.



See pages 188, 189 and 192 for our other "Ads"

Please mention SHORT WAVE CRAFT when writing advertisers



BEST BY TEST

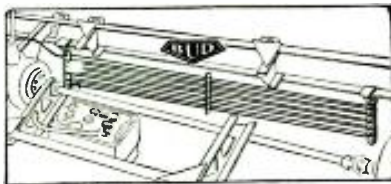

BUD UNDERCAR AUTO AERIAL

The greatest improvement in auto aerial design since the inception of auto radio. Ideal for turret top cars.

Has exceptionally good pickup. No holes to drill. Clamps securely to frame of car. Entirely out of sight. Heavily insulated wire of aerial is supported by flexible rubber tubes. Can be adjusted to any length that frame of car will permit. Rough roads or other obstructions can not injure this aerial or tear it loose.

Cat. No. 326

Price \$2.00



METAL CABINETS

Metal Cabinet to fit ALL STAR SET, EITHER SENIOR OR JUNIOR. Will also house any other set mounted on an 8" x 16" panel. Cabinet is finished in beautiful black crackle. Has hinged lid.

Cat. No. 1190

Price \$5.00

STEEL CHASSIS BASES



Build your receiver or amplifier on a BUD CHASSIS BASE. Made of heavy gauge, bright finish, cold rolled sheet steel, cadmium plated. Ends are folded down and spot welded. Supplied undrilled in the following sizes:

No. 1191—7x 7x2.....	Price \$1.05	No. 1195—10x12x3.....	Price \$1.50
No. 1192—7x 9x2.....	Price 1.10	No. 1196—10x17x3.....	Price 1.70
No. 1193—7x11x2.....	Price 1.15	No. 1197—10x23x3.....	Price 2.00
No. 1194—7x13x2.....	Price 1.20		

METAL PANELS

Heavy gauge, cold rolled sheet steel, and finished on both sides in beautiful black crackle.

No. 1200—7x 8.....	Price \$.60
No. 1201—7x10.....	Price .65
No. 1202—7x12.....	Price .75
No. 1203—7x14.....	Price .80

Listed above are but a few of the items in the complete BUD line. Write for New 1935 Catalog! All list prices shown in this advertisement are subject to 40% discount when purchase is made from an authorized BUD jobber. If your jobber cannot supply BUD parts, send your order direct to us together with your jobber's name and we will make shipment direct.

BUD RADIO INC.

1937 E. 55th STREET
CLEVELAND, OHIO

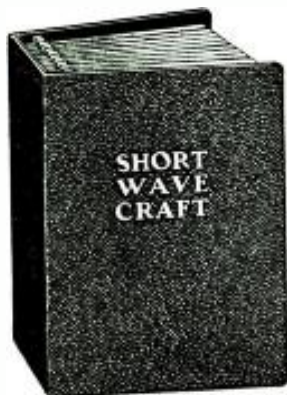

YOU DON'T

READ AND THEN DISCARD
SHORT WAVE CRAFT

Readers keep their copies for years as a steady reference and thousands of letters attest to this.

It is now possible to save your copies and for this purpose we designed a splendid binder for you which holds twelve copies. It is made of heavy substantial material and is covered with black grain leatherette. The name of the magazine is stamped in gold on the cover.

An ingenious mechanical arrangement is provided which makes it possible to hold the copies flat when reading from the binder.

SHORT WAVE CRAFT Binder as described, \$1.25 prepaid in the United States.....

Canada and foreign countries 25c extra. We accept money order, check, stamps or cash.

SHORT WAVE CRAFT

99-101 HUDSON STREET NEW YORK, N. Y.

The ABC of Automatic Volume Control

(Continued from page 144)

flowing through resistor R will cause a voltage drop to appear across it, and as the cathode of the rectifier is at ground potential and the most positive point in the circuit, a voltage is developed that is useful for A.V.C. action. Examining the cathode circuit of the preceding stage (Fig. 2A) one finds that the cathode is above ground potential (B-). The value above ground will be determined by the voltage drop across R1. Under these conditions the voltage drops across resistors R and R1 will be of the proper polarity to be additive. If the voltage drop across resistor R1 is 3 volts and the rectified voltage across R is 5 volts, then the total effective voltage applied to the grid circuit is the sum of the two voltages or 8 volts. As this voltage is negative in sense, as far as the I.F. tube cathode is concerned, it is as once apparent that the effective bias for A.V.C. control in the I.F. stage is dependent on the voltage drop across R. With any increase in I.F. signal voltage causing an increase in the value of the voltage drop across R, there will be an increase in the effective bias on the I.F. tube (controlled tube).

The normal action of a vacuum tube is such that any increase in the effective grid bias will cause a decrease in the mutual conductance of the tube, with a resultant decrease in the gain. Under the condition where the input signal is reduced then the voltage drop across R will decrease, lowering the effective bias and raising the mutual conductance factor of the tube and increasing the gain.

The voltage available for A.V.C. action in Fig. 2A is the full voltage developed across resistor R. and the moving arm of the potentiometer provides control of the audio signal voltage, which is generally amplified for loudspeaker operation. In the circuit of Fig. 2B, the full voltage available for A.V.C. is fed to the audio amplifier. In such an arrangement manual control of the volume is accomplished in the audio amplifier.

Which Tubes to Control for A.V.C.

In Fig. 3 A,B,C,D,E, circuit combinations are indicated in block diagram form, showing which tubes should be controlled if satisfactory A.V.C. action is to be obtained. The recommended arrangements indicated should be satisfactory and fit the greatest number of circuit combinations. However, there are modifications which may require special treatment. The circuits indicated here have proved satisfactory in so many applications that they are worth studying and using.

In the circuit of Fig. 3A, a conventional first detector oscillator combination is used with one intermediate frequency stage of amplification, and a duo-diode-triode second detector. In a receiver of this type, the A.V.C. action should be used on the intermediate frequency stage and the first detector stage as well. This is necessary to insure any kind of satisfactory A.V.C. operation at all. Better control of the A.V.C. action might be obtained in such a circuit by using a tube with a fairly close cut-off, such as a 24 or 6C6, instead of 58 or 6D6 tubes. It will be noted that the cut-off on the 24 and the 6C6, occurs in the neighborhood of 12 volts negative bias on the grid of the tube, while in the case of the variable mu or extended cut-off tube, this voltage must be carried out to about 35 volts negative for maximum signal control.

In small receivers of this kind, it is not generally necessary to have so complete an A.V.C. action, which in many instances may decrease the desired sensitivity to such a degree as to render the circuit unsatisfactory.

In Fig. 3B, we find the same circuit described above, with an additional radio frequency stage, operating at signal frequency ahead of the first detector. In this case the A.V.C. action is carried to the R.F.

Please mention SHORT WAVE CRAFT when writing advertisers

stage, the first detector stage, and the intermediate frequency stage. In a receiver of this kind, the R.F. tube and I.F. tube can be of the remote cut-off type. More tubes are controlled and smoother A.V.C. action can be obtained.

A.V.C. Control of 2 I.F. Stages and First Detector

In Figure 3C, an additional stage of intermediate frequency amplification has been added. Note that the radio frequency stage ahead of the first detector is not controlled with A.V.C. voltage, as it is to be operated at all times at the condition of maximum sensitivity. It is important to obtain in all receivers as high a signal level into the first detector oscillator circuit as possible, so that any noise generated in this circuit will be well over-ridden by a high signal level. The greater the gain in the radio frequency stage and the higher the input level from the antenna, the quieter will be the receiver in operation. This has been brought out time and time again in various publications, and should be adhered to wherever possible. The note indicated in regard to the A.V.C. voltage applied to the second I.F. stage in figure 3C, refers to the possibility of not putting the full applied voltage available for A.V.C. action on this tube. In many instances, due to the trouble which may be experienced from overloading in this stage, it would be wise to put a higher initial starting bias on the tube itself, and only use one-half of the voltage available for A.V.C. action. This will stabilize this stage, and tend to prevent overload, and still give some degree of A.V.C. action which may be desirable.

3 I.F. Set-up With A.V.C.

In Fig. 3D we have the condition of three intermediate frequency amplifier stages, otherwise the design is similar to the circuits covered previously. Here again, all the circuits are A.V.C. controlled, except the first R.F. stage which is worked at the condition of maximum sensitivity. The third I.F. stage on strong signals will unquestionably overload and it is highly desirable that the bias be raised on this tube to as high a degree as possible, without materially affecting the sensitivity of the receiver. Half the A.V.C. voltage available for the other tubes can be applied to this tube satisfactorily, although, in some cases, it might be wise to leave the A.V.C. action from this stage altogether.

Amplifier in A.V.C. Feed Line

The addition of an amplifier tube in the A.V.C. feed line is indicated in Fig. 3E. Here, the voltage available for A.V.C. action is amplified and rectified, permitting a wider range of A.V.C. voltage to be developed for control purposes. The problem of whether or not the second I.F. stage should be fully or partially controlled will depend upon the strength of the signals and the input sensitivity of the receiver itself, and the set-builder should be governed accordingly. The first radio frequency stage in this arrangement is not A.V.C. controlled, although the second radio frequency stage is. Here again we are trying to get a high signal-to-noise ratio in the first stage, using the second radio frequency stage as part of the automatic volume control circuit in a conventional manner.

A Simple A.V.C. Circuit

One of the simplest A.V.C. circuits is illustrated in Fig. 4. Here a duo-diode, or pentode tube is used. The full voltage available for A.V.C. action and audio frequency signal is developed across the 1/2 megohm resistor. Note that the voltage drop across this resistor, E3, is of the proper polarity to provide additional bias to the controlled stages. In practice, the voltage E1 across the cathode ground bias resistor on the I.F. stage and other stages being controlled, would be the nominal bias voltage necessary to

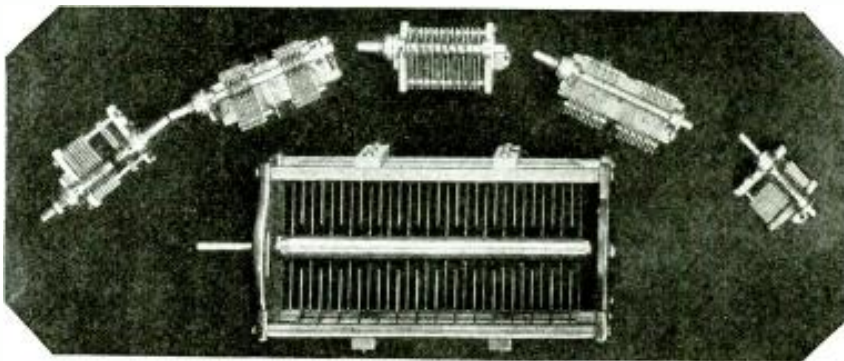

HAMMARLUND CONDENSERS

Made in 18 TYPES For Every Radio Purpose

WHATEVER your condenser need may be—for transmitting, receiving, trimming, balancing, padding, antenna tuning, etc.—Hammarlund makes it in the required capacity rating.

Eighteen different types for every radio purpose—priced at 30 cents to \$18.00 list.

And as to **QUALITY**—practically every amateur and professional operator, and every radio manufacturer throughout the world, since 1910, has respected Hammarlund prestige.

But *talk* is not *proof*. Put Hammarlund Condensers to the severest tests and let *experience* demonstrate how greatly they improve the performance of any circuit.

Write Dept. SW-7 for Details.

Hammarlund Manufacturing Co. N.R.A.
424-438 W. 33rd St., New York



It's NOW

EVERYDAY SCIENCE AND MECHANICS is the finest scientific—technical—mechanical—constructional magazine in the field. Up-to-the-minute with news flashes of scientific events. Dozens of constructional articles and many popular experiments. Ideas from which you can make things to sell.

10c

A MOST OF INTERESTING SUBJECTS COVERED:
Woodworking—Photography—Magic Patents and Inventions—Book Reviews—Metal-working—Chemistry—Engineering—Microscopy—Electrical Experiments—Household Hints—Astronomy—Prize Contests—and other subjects.



Edited by **HUGO GERNSBACK**

Get your copy today! On all newsstands

10c the copy

Over 150 Illustrations

Everyday Science and Mechanics
99-C Hudson St., New York, N.Y.

SPECIAL

FOR THIS MONTH

Send \$1.00 (\$1.25 Canada and foreign) and we will send you **SHORT WAVE CRAFT** for Eight months. **DO IT NOW!**

SHORT WAVE CRAFT
99-101 Hudson Street New York

LEARN CODE

BE A REAL radio operator. Make money with radio. Get your **COMMERCIAL OR AMATEUR TICKET**. Be an **EXPERT!** Ted McElroy on March 11 at Chatham, Mass., *officially* copied 77 words per minute, Continental Code, *without error*, breaking all records. Think of it—77 words per minute!



He's Candler trained! Most of the holders of Extra First Class Commercial Licenses are Candler men. Candler will teach you the method he has taught ALL of the Champion operators. (Australians: write W. Johnston (VK2YZ), 1 Searle St., Ryde, Sydney, Australia)



FREE

Free copy of "BOOK OF FACTS for RADIO OPERATORS." **TEAR OUT** this ad, write your name and address in the margin. Or a card will do. No obligation.

CANDLER
6343 SOUTH KEDZIE AVE., Dept. S7, Chicago.

WORLD-WIDE RECEPTION IS YOURS

4 VALUABLE FREE CIRCUITS

1. Leonard Victor E. C. Four
2. Marlin Playboy "6" all-wave
3. Eagle "7" all-wave super
4. Quadryne 2-tube A.C. D.C.

Just write your name and address on post card and mail to-day to
EAGLE RADIO, 84 Cortlandt St., N. Y. City

Please mention **SHORT WAVE CRAFT** when writing advertisers

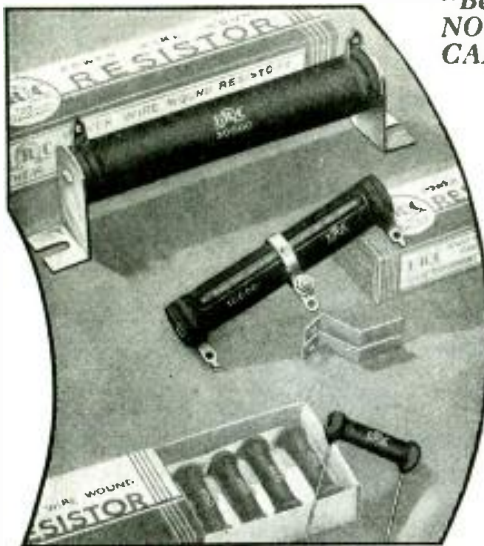

**"Be not the first to try the new—
NOR YET THE LAST TO DIS-
CARD THE OLD!" ...**

Throughout the world, wide-awake servicemen and hams are turning to IRC CEMENT COATED Power Wire Wound Resistors because impartial tests have shown—

- Lower surface temperature —longer life.
- Greater load capacity and greater mechanical strength.
- Non-porous ceramic core avoids absorption of moisture.
- Moisture and humidity proof.

FOR SERVICEMEN	FOR HAMS
Type PB 10-Watt List 35c	Type PGA 100-Watt 50,000 ohms List \$2.00

All popular values and ratings carried by leading jobbers. Write for Catalog R-24.

INTERNATIONAL RESISTANCE CO.,
2100 Arch St., Philadelphia, Pa.
187 Duchess St., Toronto, Ont., Canada
(Prices slightly higher in Canada)

IRC POWER WIRE WOUND RESISTORS CEMENT COATED

WORLD WIDE ALL WAVE RADIO

The Ace  A real powerful long and SHORT WAVE Radio Receiver that actually gets local and foreign broadcasts, police, amateur, airplane, etc., transmissions direct! Thousands now in use. Owners report reception of Foreign Stations with amazing volume. Works on two inexpensive batteries.

\$195

Not a toy! RESULTS GUARANTEED!
Ace construction kits have all necessary parts mounted on attractive metal chassis and panel, all ready for wiring. Clear picture diagrams. Wire it yourself. It's easy. Only 3 connections and the set is ready to operate. Wave-length range 15 to 600 meters. Complete Kits, with coil:

● ONE TUBE KIT, \$1.95 ● TWO TUBE, \$2.85

ALL ELECTRIC 105-125 Volt AC-DC two-tube house current set. No batteries needed! Complete Kit... \$3.65
Kits wired, 75c extra. Tubes, 75c ea. Double phone, \$1.25
ORDER NOW! Send \$1. balance C.O.D., or if full remittance with order, we pay postage.

ACE RADIO LABORATORIES
1619 Broadway Dept. C-7, New York City

STOPPANI COMPASS

A Precision Instrument made in Belgium. Purchased by the U. S. Government at more than \$30.00 each. Ideal for Radio Experimenters Laboratory, also may be used as a Galvanometer for detecting electric currents in radio circuits. Ruby, jeweled, solid bronze, 4 inches square, fitted in a hardwood case.



Our price prepaid \$4.50 each

Gold Shield Products Co., 17 West 60th St., N. Y. City

obtain the maximum gain. While the value of resistor R in the cathode circuit of the duo-diode-triode tube will be dependent on the requirements of the particular type of tube used, it would be well to note that the voltage E2 dropped across this resistor is in the wrong polarity sense, in respect to the cathodes of the control tubes. For example, if the voltage drop in E1 is 3 volts, and the voltage drop in E2 is 6 volts, then the bias nominally available for control with no A.V.C. signal voltage developed, would be plus 3 volts effective on the grid of the controlled stages. This, of course, cannot be tolerated and it then becomes necessary to raise the voltage E1 so that the bucking voltage created across E2 will not put a positive potential on the control grid, under the condition where voltage E3 is equal to 0.

Many set-builders have found this condition to exist when using the type 55 duo-diode-triode transformer coupled, in which case E2 would run between 13 and 15 volts. It is readily apparent that there would be a 12-volt positive bias supplied to the control grid of any tube connected in this A.V.C. circuit. If duo-diode-pentode tubes are used, then the voltage E2 is generally in the order of 2 volts and it is a simple matter to increase E1 to approximately 5 volts, thus having an effective bias on the tube of approximately 3 volts with no A.V.C. voltage being developed at E3. In that case, any voltage developed in E3 will be in the proper sense, so far as polarity is concerned, to insure adequate control. Resistor R1 and condenser C1 serve as a radio frequency filter unit in this particular arrangement, thus preventing the flow of radio frequency current in the grid circuit of the audio frequency portion of the tube. If radio frequency currents are permitted in the grid circuit of the audio portion of the tube, unstable operation will be the result, which oftentimes is improperly diagnosed as oscillation in the intermediate frequency amplifier. No further comments should be necessary on this particular circuit as similar circuits or slight modifications have appeared in print from time to time.

Delayed A. V. C.

A circuit wherein the action of the A. V. C. voltage is delayed some predetermined amount, is illustrated in Fig. 5. Here the voltage drop across resistor R, which incidentally determines the bias on the control grid of the triode portion of the duo-diode-triode tube, serves as the delay voltage. In this circuit, one of the diode plates functions as the rectifier circuit and the radio frequency energy in this circuit is conducted by means of the condenser to the remaining diode plate; this returns to ground through the 1 megohm resistor. A study of the circuit will show that voltage greater than the voltage drop across resistor R will be necessary before any A. V. C. action can take place. This permits the operation of the receiver at high levels of sensitivity over a greater input signal range before A.V.C. action starts than that which can be obtained with the circuit in Fig. 4. If a duo-diode-pentode tube is used, such as a 6A7, or a 2A7, in their detector audio amplifier position, then the voltage drop across R for normal operation of the audio portion of the tube will be less, and the voltage available for the delay will, of course, be decreased proportionately. The audio frequency signal voltage is taken from the potentiometer and a .1 meg. resistor and a .00025 mf. condenser serves to isolate any radio frequency current from the audio frequency portion of the tube.

A simple switching method is shown so that the A.V.C. voltage can be thrown in or out of the circuit, as the case may be. This is an especially valuable feature when using the receiver for C.W. code reception where automatic volume control does not work out so satisfactorily.
(Part II—Conclusion, will cover such important subjects as—"obtaining sufficient voltage to operate A.V.C. properly"—"How to obtain push-pull coupling without a transformer, from a single triode or pentode, into a pair of pushpull tubes."—Editor.)

Most Amazing Typewriter Bargain EVER OFFERED

NEW REMINGTON PORTABLE ONLY 10c A DAY

FIRST TIME! Remington's new purchase plan now lets you buy a genuine latest model Remington Portable No. 5 direct from the factory for only 10c a day. Not used or rebuilt. Not incomplete. A beautiful brand new regulation Remington Portable. Standard 4-row keyboard, standard width carriage, margin release on keyboard, back spacer, automatic ribbon reverse; every essential feature found in standard typewriters.

FREE With your machine we send you free a 19-page course in typewriting. Teaches touch system quickly, easily. Soon you dash off letters quicker than with pen and ink. You also get a handsome, sturdy carrying case, free.

BIG PRICE REDUCTION
The amazing low price and easy terms now make it possible for you to buy this genuine, complete Remington Portable for only 10c a day. But we cannot guarantee present prices long. Higher wage scales, rising cost of materials, everything points to higher prices. So we say, "Act now... while our liberal offer still holds good!"

YOU DON'T RISK ONE CENT
Try this typewriter in your home or office on our 10-day FREE TRIAL OFFER. Then if you do not agree that it is the

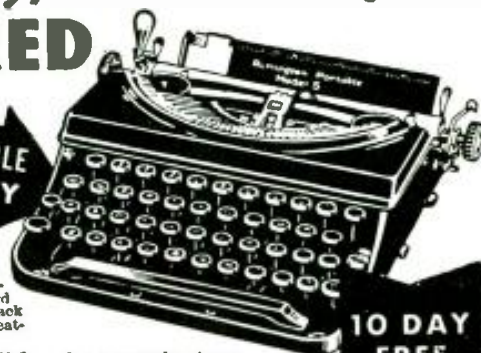

finest portable at any price, return it at our expense. You don't even risk shipping charges. It's the best chance you've ever had to own so complete a machine for so little money. So don't delay. Mail the coupon NOW!

CLIP COUPON

Remington Rand Inc., Dept. 214-7, 205 E. 42nd Street, New York City

Please tell me how I can buy a new Remington Portable typewriter for 10c a day. Also send your new catalog.

Name _____
Address _____
City _____ State _____

Please mention SHORT WAVE CRAFT when writing advertisers

Antenna Broadside to Waves

As antennas respond best when placed broadside to oncoming radio waves, the engineers were fortunate in finding that strands strung between the towers would actually be *broadside* to those points on the globe where the majority of short-wave stations are located. Being crisscrossed, the wires face broadside at various angles, thus presenting the most favorable front. End on, their least effective direction, they point on one hand toward the watery wastes of the South Atlantic and on the other toward the North Pacific.

In picking or intercepting certain waves from out of the ether, the antenna performs the first step in a continuous process of

Five circuits, tuned to the desired signal, single it out and then, still at high frequency, it enters a vacuum tube which "beats" it down to 385 kilocycles. The signal passes to an intermediate frequency amplifier where its energy is amplified about 100,000,000,000 times. A high-fidelity detector tube translates this radio frequency into audio frequencies, the electrical equivalent of sound. These cover the wide range of tones necessary for faithful reproduction of sound. These are once more amplified and then pass into the hotel's present 6-channel program distribution system.

S-W Receivers, Specially Selective

The outstanding feature of the receiving units is their high degree of selectivity. At one point the circuits are tuned by six condensers operated simultaneously by a single control through an accurate worm-gear reduction drive. In the intermediate frequency amplifier there are eight additional fixed tuned selective circuits. Such refinements make possible the accurate tuning required in the short-wave realm where channels may be separated by as little as .1 percent, as

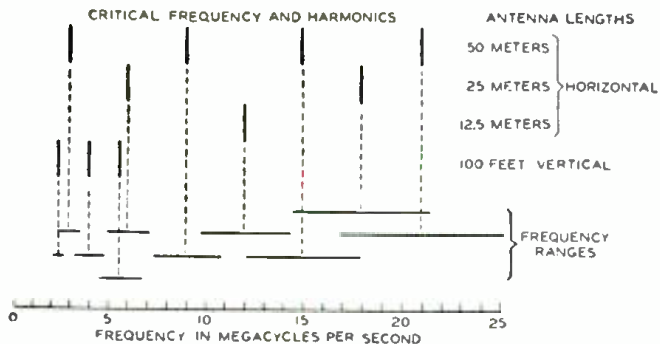

Chart showing how the responses of the strands in the short-wave antenna cover the various short-wave channels.

selection and refinement which is carried to its conclusion in the radio apparatus located in the heart of the hotel. Again and again the radio signal intercepted by the antenna is filtered through tuning coils, condensers and vacuum tubes until the voice of the desired station, thousands of miles away, issues pure and clear.

Special Lead-in 600 ft. Long

From the antenna, the impulse flashes down the lead-in wire to the roof where it enters a specially designed transmission line down which it surges 600 feet into the radio room on the sixth floor. This line prevents any electrical loss and is protected completely from the countless interference waves which it would otherwise pick up over this long run.

The signal now enters the short-wave receiver, a cabinet about 7 feet high containing a number of panels of sensitive equipment. Its first units are three amplifiers, one covering 2,200 to 6,000 kilocycles, another 6,000 to 13,000 kilocycles and a third 12,000 to 25,000.

for instance at 20,000 kilocycles where the next station is only 20 kilocycles away.

Various devices overcome the natural caprices of short-wave reception at great distances. A switch alters the band of audio or sound frequencies. In one position it admits the wide band. Should noise or other interference creep into the signal on its long journey, the device may be used to narrow down the band of frequencies admitted in which case, according to the engineers, "it throws away more noise than speech." Sudden fading which occurs in short waves is overcome by automatically increasing amplification to maintain a steady volume.

The receiving units are similar in design to those used at the Bell System stations at Netcong, New Jersey, the link in telephone service between North and South America, and at Miami in telephone service with the Caribbean countries. They are also used in ship-to-shore telephone service.

In next issue! The new 1935 "DOERLE" Receiver. Brand new features! Don't miss this article!

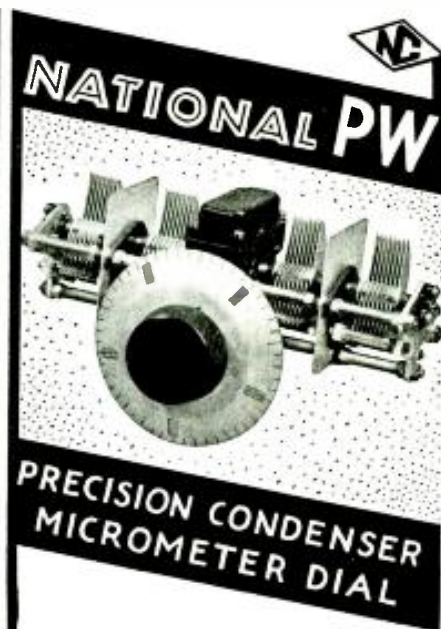

A remarkable new unit, electrically and mechanically far in advance of anything of its kind ever offered before. It overcomes the drawbacks of ordinary ganged condensers when used in Short Wave Receivers, combining electrical design of exceedingly low-loss characteristics, with a rigidity and accuracy of construction that is comparable to that found in a fine microscope or a tool-maker's lathe.

Has 20-1 ratio pre-loaded worm-gear drive in enclosed die-cast gear housing; 3/8" steel rotor shaft on 4 insulated bearings. Rigid 180° S.L.F. type Condenser sections with rotor sections separately insulated with Steatite-Isolantite, are mounted directly on gear housing; Micrometer Dial has 50 divisions and makes 10 revolutions in covering tuning range, reading directly to 1 part in 500. Numbers every 10 divisions on dial rotate with it but change automatically every revolution. Quality—not price, comes first in every detail of this outstanding unit.

List Price (subject to 40% discount when purchased through an Authorized NATIONAL DISTRIBUTOR), PW-1, Single Section \$13.50; PW-2, Two Section \$17.00; PW-3, Three Section, \$20.50; PW-4, Four Section \$24.00.

USE COUPON BELOW



National Company, Inc.
Malden, Massachusetts

Gentlemen:
Please send me your new catalogue No. 240. I enclose 6c to cover mailing costs.

Name
Address

SWC-7-35

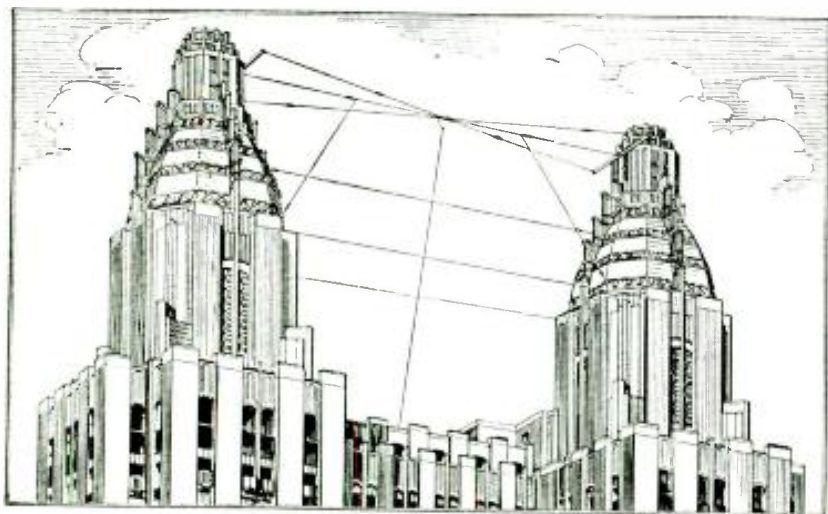

The Waldorf-Astoria Hotel, New York City, with its twin towers, rising 660 feet above the street level, between which is strung the antenna array which serves as the pick-up for the largest all-wave radio receiving system in the world.

Please mention SHORT WAVE CRAFT when writing advertisers

4,600 Short-Wave Stations are listed in this magazine!

NEW

WE ARE happy to present to the thousands of short wave fans this new magazine which enthusiastic readers of Short Wave Craft have urged us to publish. Here is a book that you will feel proud to possess because it reflects your patience and perseverance in logging distant stations. It is a record you will be proud of in days to come. It is the finest and most complete book of its kind ever published. There is nothing like it on the market now, nor was there ever a book published like it before.

4600 SHORT WAVE STATIONS
It contains the largest listing of short wave stations in the world, a much larger list in fact than the list published in SHORT WAVE CRAFT, or any other magazine. Due to space limitations, no regular magazine can publish all the world stations. There are so many short wave stations, which normally cannot be included in any monthly magazine list, but frequently you hear these calls and then you wish to know from where they originate. The OFFICIAL SHORT WAVE LISTENER gives you this information, besides a lot of other information which you must have.

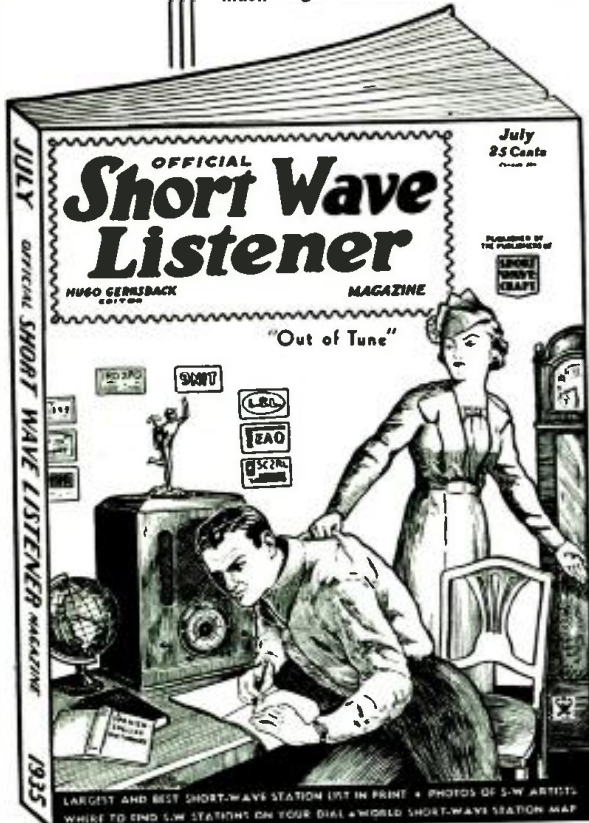

to space limitations, no regular magazine can publish all the world stations. There are so many short wave stations, which normally cannot be included in any monthly magazine list, but frequently you hear these calls and then you wish to know from where they originate. The OFFICIAL SHORT WAVE LISTENER gives you this information, besides a lot of other information which you must have.

●
ASK YOUR NEWS DEALER FOR A COPY OF THIS NEW SHORT-WAVE MAGAZINE

●
25c the Copy Well Illustrated

Contents of the July Issue:

Talking "Around the World" By Short Waves
Short-Waves Stars of Station PHI, Holland.
Where to Find the Short-Wave Stations on Your Tuning Dial
How to Get Maximum Results from Your SW Set by George W. Stuart
The Latest Style in Doublet Aerials
Why Is a Multi-Tube Set Superior to a 1 or 2 Tube Set?
Short-Wave "Fiction" Story
Photos of Short-Wave Artists From India, U.S.S.R., and Other Countries
Silver Cup Trophy Contest for the Best "Listening Post" Photo
Grand List of Short Wave Stations of the World—With Call Letters and Frequencies, Including "Police" and "Television" Stations
"Star" Short-Wave Station List
Newest Ideas in Short Wave Receivers
"Musical Signatures" and Foreign Language Alphabets—A Great Help in Identifying Stations
"The Listener Asks"—Short Wave Question Box

From this you will see that the magazine has been designed as a companion magazine to SHORT WAVE CRAFT.

If you are now a reader of SHORT WAVE CRAFT magazine, you will not wish to be without THE OFFICIAL SHORT WAVE LISTENER MAGAZINE. The new magazine will help you tremendously in your short wave reception at all times, and will give you priceless and invaluable information, such as you cannot get anywhere else. Nothing like it appears in print anywhere today. THE OFFICIAL SHORT WAVE LISTENER MAGAZINE, in other words, is a necessity.

P. S.—If you cannot get the magazine at your newsstand due to sell-out, send 25c in cash, stamps or money order, and we will send the magazine to you direct, prepaid.

OFFICIAL SHORT WAVE LISTENER MAGAZINE
99 Hudson Street, New York, N.Y.

Please mention SHORT WAVE CRAFT when writing advertisers

The "Browning 35"—All-Wave Receiver

(Continued from page 154)

The Heart of the "35"

This tuner is the "heart" of the "Browning 35" around which the set is built. It contains in a single unit the 3-gang variable tuning condenser, with its vernier control; twelve tuning coils, three for each of the four separate frequency ranges, in separate shielded compartments; a trimming condenser for each one of these twelve coils, together with the variable and fixed padding and tracking condensers.

The SUPER TUNER also contains a silver-plated, multiple band, selector switch which passes through the shielded compartments with a coil-switching unit in each compartment. By means of the unique wiring arrangement of this switch the coils not in use are isolated and short-circuited. The individual parts of the unit are carefully arranged and spaced from the shielding walls to keep inductive losses and stray capacities at a minimum. Not only is the SUPER-TUNER completely assembled and wired at the factory, but the circuits and trimming condensers are also aligned and preadjusted; the R.F. detector and oscillator circuits are all synchronized and ready to operate. Thus the complicated and critical part of the electrical and mechanical construction is eliminated and the remaining assembly and wiring work on the chassis can be done by anyone familiar with the use of soldering iron, pliers, and screwdriver.

Unique Construction Plans

Having solved the problem of how the amateur could construct such an advanced type of set by utilizing the SUPER-TUNER, our next concern was that the remaining assembly and wiring work should be made as clear and foolproof as possible. Accordingly five full-size drawings are furnished with each kit. The first shows a large schematic diagram of the circuit. Drawing No. 2 shows how to assemble the parts. No. 3 shows in detail all wiring on the chassis, including the filament and power supply, variable sensitivity and volume controls, switches, etc. Diagram No. 4 shows the connection of every fixed resistor and no other wiring. Diagram No. 5 shows how to mount and connect each fixed condenser and no other wiring, except the seven connections which are made last of all to the SUPER-TUNER.

In building the set these diagrams are used in order. The parts (sockets, power transformer, variable resistor controls, switches, etc.) are first mounted as shown in Diagram No. 2. Then the general wiring is done from point to point exactly as shown in Diagram No. 3. The small fixed resistors are next connected to the sockets and special brackets provided for them in accordance with Diagram No. 4. Then the condensers are connected as in Diagram No. 5. Finally the SUPER-TUNER connections are made. The tuning unit should not even be mounted until all wiring and other work have been completed. This makes it easier to work on the chassis without danger of harming the tuning unit which must be handled with a reasonable amount of care to preserve its adjustment.

Circuit Includes Preselector

The superheterodyne circuit used in the "Browning 35" has several unique and advanced features, which are—in large part—responsible for the exceptionally fine performance it is giving on long distance reception.

In the first place the stage of tuned R.F. amplification or preselection, as it is sometimes called, which is used ahead of the 2A7 mixer tube on all bands really amplifies. If this part of the circuit is not very carefully designed it will prove more of a liability than an asset on the high frequencies, decreasing the sensitivity instead of improving it. Silver-plated wire is used in the high frequency tuning coils in both the R.F. and detector circuits, and

every precaution is taken to eliminate resonant circuit losses ahead of the mixer tube. It is this part of the circuit which must be depended on to eliminate "image" and "pseudo image" frequencies which are so annoying, even in many of the higher-priced receivers. Moreover, if a reasonably high order of amplification can be obtained in this preamplifier, and this is

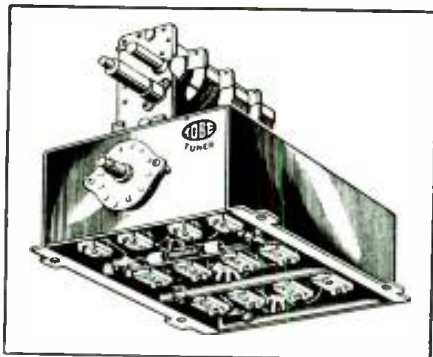

View of Tube Tuner

entirely practicable with the help of a 58 supercontrol tube and low-loss circuits, it permits the use of less intermediate frequency amplification which helps tremendously in reducing the noise-level of the entire receiver.

Tuning Range from 13.2 to 555 Meters

The "Browning 35" covers the whole short and long wave broadcast tuning range up to 555 meters, or the entire frequency spectrum between 22.6 and .54 megacycles. Its sensitivity throughout this wide range is better than one microvolt which means that the R.F. gain is greater than can be used except under the most favorable atmospheric conditions in a very "quiet" receiving location. It can be seen from the accompanying sensitivity curves that the response on any one band is almost uniform while the entire variation over all four bands is unusually small. The uniformity of these curves is a direct indication of the high efficiency of the all-wave tuning unit employed.

The receiver is absolutely *single-control*. The twelve trimming condensers and four tracking or padding condensers in the SUPER-TUNER unit make it possible to maintain accurate synchronism between the pre-selector, detector and oscillator circuits over the entire frequency range.

Band-Spread Over Entire Range

Tuning is done with a 40 to 1 ratio microvernier dial. Stations are logged by reference to two pointers, one on the main shaft of the tuning condenser and the other on the vernier shaft. The vernier dial has a 2 1/2" diameter and covers 360°. Thus continuous *band-spread* is accom-

plished over the entire tuning range. The advantage of such tuning control can be seen by considering one individual band. Take, for instance, the highest frequency band which tunes from 22.6 megacycles (13.2 meters) to 8.8 megacycles (34 meters). On the large calibrated dial this band is 8 1/2" long. While the long pointer on the main dial is covering this distance the vernier pointer makes 20 complete revolutions on its 2 1/2" scale, covering actually 15 3/4". The 20-meter amateur phone band, which is only 100 kilocycles wide, covers 72° on the 2 1/2" vernier dial!

Oscillator Is Electron-Coupled

The beat frequency oscillator is combined with the first detector and electronically coupled to it in the 2A7 tube. This precludes any "locking-in" effects between the antenna or R.F. stage and the oscillator. Another feature of the oscillator circuit is the parallel voltage feed to the anode. This can be seen by reference to the accompanying schematic circuit diagram, where the 20,000-ohm resistor is shown in series with the power supply and in parallel with the plate inductance of the oscillator. This circuit arrangement tends to keep the R.F. output of the oscillator at a constant level over its tuning range and permits more efficient operation of the mixer.

Double Band-Pass Filter

Only one stage of intermediate frequency amplification is used. This was done deliberately in preference to using two or more stages, and not for the sake of economy. The 58 supercontrol tube, which is used here, has an amplification factor of 1280 and, when used with effective high impedance grid and plate coupling, is capable of delivering as much intermediate R.F. amplification as can be used under actual operating conditions.

It is common practice to make use of two or more intermediate stages of amplification operating at low efficiency, each slightly off resonance with the other, in order to obtain a selectivity and amplification curve which is not too sharply peaked. While this is good theory, from a practical standpoint the results are not always satisfactory. Tube capacities vary, their characteristics change and tuned circuits shift their peaks. An oscillator, together with an oscillograph, are necessary to properly readjust such an I.F. amplifier.

The "Browning 35" makes use of a double band-pass filter to accomplish this purpose. Six tuned circuits are employed in this one I.F. stage, two of these being link circuits which are conductively connected only to ground, and are consequently not affected by tube variations, etc. Three of these filter circuits are contained in each of the two I.F. transformers, the center one in each case being the independent link circuit. It is a simple matter to align these circuits at any time by merely adjusting the two outside circuit condensers in each transformer so that their circuits are in resonance with

FREE

TO WINNERS OF SWST with BB's-



A WHOLE YEAR'S SUPPLY OF BURGESS BATTERIES!

Wire new BB's (BURGESS Batteries) to your set. They'll give it the full power, the razor-edge selectivity, the heightened sensitivity you need to win the SWST (Short Wave Scout Trophy). ● Tune in a prize-winning number of stations. Mail your record to Short Wave Craft. WIN the SWST—and get a year's supply of BB's (all your set can use in a year!) absolutely FREE. ● A year's supply of BB's FREE, if your prize-winning set is powered by BB's! Visit your nearest dealer and get those new BB's—and pick a prominent spot for your SWST. BURGESS BATTERY CO., Freeport, Ill.

BURGESS Power House



BURGESS "B" and "C" Batteries

BURGESS BATTERIES AND FLASHLIGHTS

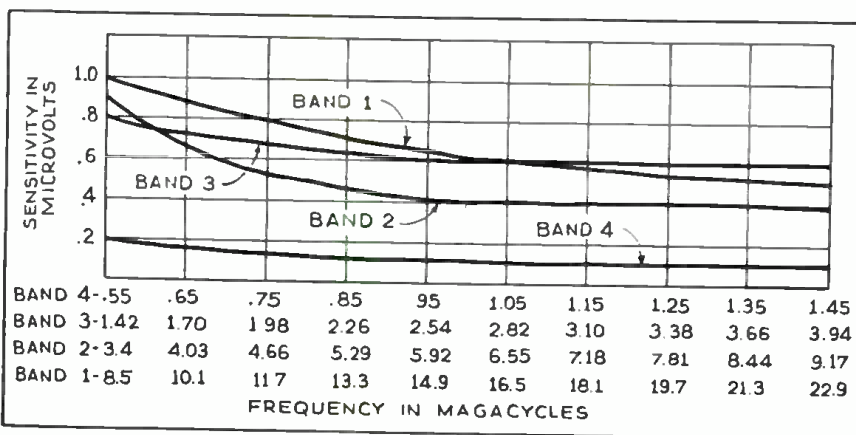

Sensitivity Curve for "Browning 35" Receiver

Please mention SHORT WAVE CRAFT when writing advertisers

If you want THE BEST, order BRUSH PIEZO-ELECTRIC HEAD PHONES—TYPE A

A high impedance type head phone which has extremely high current sensitivity and finds ready application in a wide variety of uses, especially where it is not desirable to draw an appreciable amount of current.



Brush Type A piezo-electric head phones are ideally suited to the short wave amateur and experimenter due to their sensitivity. They can also be used extensively in the laboratory.

The driving mechanism of Brush Type A piezo-electric head phones is assembled in a distinctive brown octagonal bakelite case, which is fireproof, of tough, durable construction and very light in weight—the entire assembly, including cords and head bands weighing only six ounces.

They have a response from 60 to 10,000 cycles, which wide range makes them applicable to any type of work where the higher frequencies are especially important.

The high impedance and great sensitivity enable the phones to be operated from any normal source, regardless of the impedance.

If you wish to learn of its many uses, construction, electrical characteristics, operation, specifications and further details, write today for BRUSH DATA SHEET NO. 10.

List Price **\$12.00**

THE BRUSH DEVELOPMENT CO.
East 40th Street & Perkins Avenue, Cleveland, Ohio

the link circuit. This is done by listening to the noise level in the loudspeaker and simply adjusting the top and bottom tuning condensers in the transformers for loudest volume.

After much experimenting 456 kc. was chosen as the best intermediate frequency for the band-pass filter and the six circuits are preadjusted for this frequency at the factory. This adjustment is made on R.C.A. tubes, but regardless of tube variations the link circuits remain on 456

kc. and it is a simple matter to bring the others into resonance as described above.

Further advantages gained by the use of this band-pass I.F. filter in selectivity and quality of reproduction will be given next month together with a description of the remainder of the circuit which includes linear diode rectification in the final detector, automatic and manual volume control, sensitivity control, a beat frequency oscillator and resistance-coupled audio amplification.

Beginner's All-Electric S-W Receiver

(Continued from page 141)

supply is used with other sets. However, for this set no taps were needed and the straight 15,000-ohm, 35-watt resistor was used. If a dynamic speaker is used the field coil can take the place of the second filter choke and should have a value of 1800 to 2000 ohms.

The chassis used for both the power supply and the R.F. and audio section are of aluminum and measure 4 x 9 x 1 1/2 inches,

making a really compact receiver. The photographs clearly show the placement of the various parts. We recommend that the very same layout be used, if best results are to be expected. The antenna used during the tests performed with this receiver was 75 feet long and gave fine results. Nearly every foreign S-W broadcast station was heard on the loudspeaker—and with very comfortable volume.

"3"-WINDING COIL DATA

6 pin base for use with .00014 mf. (140 mmf.) tuning condenser

Band	W.L. meters	Primary*	Secondary	Tickler	Dis. bet. Tick. & Sec.
10-20		4T. No. 32 S.S.C. Interwound with sec. turns (tickler end.)	5T. No. 26 S.S.C. wound 1/8" pitch bet. turns.	5T. No. 32 S.S.C.	3/32"
20-40		8T. No. 32 S.S.C. Interwound with sec. turns.	11T. No. 26 S.S.C. wound 3/32" pitch bet. turns.	7T. No. 32 S.S.C.	3/16"
40-80		15T. No. 32 S.S.C. Interwound with sec. turns.	23T. No. 26 S.S.C. wound 5/64" pitch bet. turns.	8T. No. 30 S.S.C.	3/32"
80-200		31T. No. 32 S.S.C. Interwound with sec. turns.	50T. No. 30 S.S.C. wound 1/32" pitch bet. turns.	16T. No. 30 S.S.C.	5/32"

*Tickler coil wound at bottom or pin end of 1/4" dia. form. Prim. Turns interwound at lower end of Sec. (nearest tickler). This winding not used on "antenna" coil.

IMMEDIATE DELIVERY The SUPER-SKYRIDER



- SUPER-SKYRIDER (13 to 240) complete.....\$59.95
- SUPER-SKYRIDER (13 to 240) with Crystal, Complete..... 68.95
- SUPER-SKYRIDER (13 to 550) Complete..... 69.95
- SUPER-SKYRIDER (13 to 550) with Crystal, Complete..... 78.95
- SUPER-SKYRIDER (10 to 240) Complete..... 69.95
- SUPER-SKYRIDER (10 to 240) with Crystal, Complete..... 78.95
- MARGENT 8-34 (15 to 550) Complete..... 54.50
- MARINE MODEL 8-34 (15 to 1500) Complete 62.50
- PATTERSON PR-12 (8 to 550) Complete..... 83.70
- With crystal, complete..... 89.70
- RME-9D (13 to 550)..... 112.50
- Complete with tubes, speaker, speaker cabinet, etc..... 127.50
- RCA-ACR 136 (15 to 550) Complete..... 69.50
- McMURDO-SILVER 5C (13 to 200) Complete... 74.70
- PRE-SELECTORS..... 14.75
- MARGENT, complete..... 17.64
- PATTERSON, complete..... 19.80
- PEAK, less tubes.....

SHIPPED PREPAID if full purchase price accompanies your order (RME-9D and RCA-ACR-136 excepted)

MARINE RADIO COMPANY

(Formerly L. I. Marino & Electric Co.)
124-07 101st Ave., Richmond Hill, New York City
Tel. Cleveland 3-2400. Cable Address "Elecmarine"

WHEN BETTER AERIALS ARE MADE LYNCH WILL MAKE THEM... AND OTHERS WILL TRY TO COPY THEM

Write for Free Bulletin on LYNCH PATENTED and GUARANTEED Noise-Reducing Antennas for Home, Auto Use.
ARTHUR H. LYNCH, INC., 227 Fulton St., N. Y. PIONEER OF NOISE-REDUCING AERIALS

This bottom view shows the placement of parts. Note that the panel is spaced from the chassis to accommodate the antenna trimmer and regeneration control.

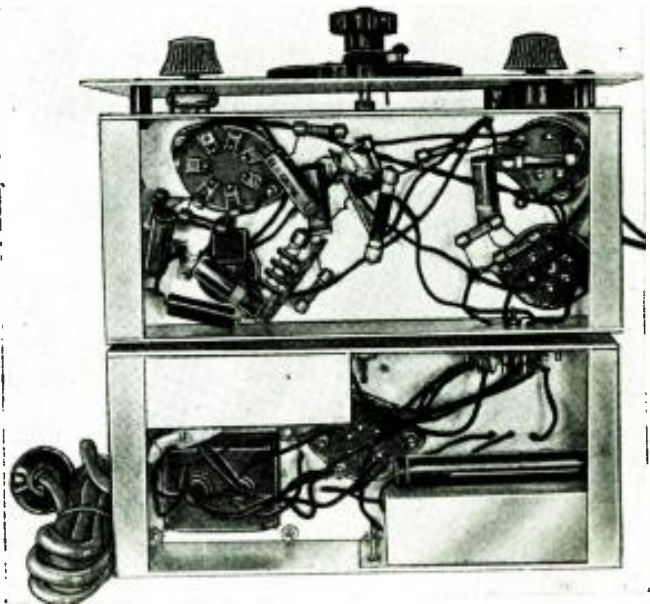

ARTICLES ON GOOD 1 TO 5 TUBE SETS WANTED!

The Editors are looking for good set construction articles on:

- A—One and Two Tube Receivers.
 - B—Sets using new "dual-purpose" tubes.
 - C—S-W Converters of efficient type and proven worth.
 - D—Transmitters, low-power, efficient types, and allied "Ham" station apparatus including Monitors, etc.
- Send diagrams of set first and photo for editor's opinion, before shipping set.

Please mention SHORT WAVE CRAFT when writing advertisers

Short Wave Stations of the World

(Continued from page 159)

5853 kc. WOB
-C- 51.26 meters
LAWRENCEVILLE, N. J.
Calls Bermuda, nights

5850 kc. YV5RMO
-B- 51.26 meters
MARACAIBO, VENEZUELA
5:15-9 p. m.

5825 kc. TIGPH
-B- 51.5 meters
SAN JOSE, COSTA RICA
6:15-11 p. m.

5790 kc. JUV
-C- 51.81 meters
NAZAKI, JAPAN
Broadcasts 2-7:45 a. m.

5780 kc. HILJ
-B- 51.9 meters
SAN PEDRO DE MACORIS,
DOM. REP.
7-9:30 p. m.

5780 kc. OAX4D
-B- 51.9 meters
P.D. Box 853
LIMA, PERU
Mon., Wed. & Sat. 9-11:30 p. m.

5714 kc. HCK
-B- 52.5 meters
QUITO, ECUADOR, S. A.

5660 kc. HJ5ABC
-B- 53 meters
CALI, COLOMBIA
11 a. m.-12 N.
Tues. and Thurs. 6-10 p. m.
Sun. 12 N.-1 p. m.

5077 kc. WCN
-C- 59.08 meters
LAWRENCEVILLE, N. J.
Phones England irregularly

5025 kc. ZFA
-C- 59.7 meters
HAMILTON, BERMUDA
Calls U.S.A., nights

4975 kc. GBC
-C- 60.30 meters
RUGBY, ENGLAND
Calls Ships, late at night

4820 kc. GDW
-C- 62.24 meters
RUGBY, ENGLAND
Calls N.Y.C., late at night

4752 kc. WOO
-C- 63.1 meters
OCEAN GATE, N. J.
Calls ships irregularly

4600 kc. HC2ET
-B- 65.22 meters
Apartado 249
GUAYAQUIL, ECUADOR
Reported Wed., Sat. 9-11:30 p. m.

4320 kc. GDB
-C- 69.44 meters
RUGBY, ENGLAND
Tests. 6-11 p. m.

4273 kc. RV15
-B- 70.20 meters
KHABAROVSK, SIBERIA,
U. S. S. R.
Daily, 3-9 a. m.

4272 kc. WOO
-C- 70.22 meters
OCEAN GATE, N. J.
Calls ships irregularly

4098 kc. WND
-C- 73.21 meters
HIALEAH, FLORIDA
Calls Bahama Isles

4002 kc. CT2AJ
-B- 74.95 meters
PONTA DELGADA,
SAO MIGUEL, AZORES
Wed. and Sat. 5-7 p. m.

3543 kc. CR7AA
-B- 84.67 meters
P. O. BOX 394
LOURENCO MARQUES, MO-
ZAMBIQUE, E. AFRICA
1:30-3:30 p. m., Mon., Thurs.,
and Sat.

3490 kc. PK1WK
-B- 85.96 meters
BANDONG, JAVA
Daily except Fri., 4:30-5:30 a. m.

All Schedules Eastern Standard Time

New Low-Resistance Carbon Resistors for Tuned Circuits

● IT is generally acknowledged that in many cases it is desirable to introduce low-resistance values in some tuned circuits for the purpose of giving a more uniform sensitivity curve. This is particularly true in the case of radio receivers and industrial electronic control apparatus having more than one wave-band tuning. For such purposes, the close approach of carbon type resistors to pure noninductivity is generally recognized, but the difficulties of producing carbon resistors in low values which will maintain stability have hitherto proved insuperable.

Now, however, a new series of resistors in values as low as .04 ohm is being manufactured and sold. This is known as the "LV" series. These new low-value carbon resistors are said to conform in every way to the standards established by the regular line of this company's resistors as to voltage, life, load, overload and humidity characteristics. In fact, the manufacturer's laboratory tests indicate that these resistors are capable of standing up satisfactorily, for example, under heat-humidity conditions much more severe than those imposed by the R.M.A. specifications.

This ability to function properly under such conditions is particularly important because radio and control apparatus shipped for export may be required to operate satisfactorily in the "hot-house" humidity of a tropical rainy season.

At present, LV resistors are made in ratings from 1/4 watt to 10 watts in all resistance values. The new type rounds out the complete range from .04 ohm to 100 megohms. (No. 294)

YOU Can Easily Try out all the Latest Circuits with the new "Clip-Set"—See next Issue!!!



Major Armstrong Perfects "Frequency Modulation"

● MAJOR EDWIN H. ARMSTRONG, well-known for his accomplishments in the radio field, has just announced the perfection of a new system for ultra-high-frequency radio transmission and reception. This system depends upon the modulation of frequency rather than changes in amplitude of the transmitted wave.

As most of us know, the accepted method for transmission of voice is where the carrier frequency is maintained absolutely constant in frequency and is varied in amplitude at voice or audio frequencies. Mr. Armstrong's plan is just the opposite of this, in that the amplitude or strength of the carrier is maintained constant, but varied in frequency by the imposed audio frequency sounds. By constructing a receiver which is not sensitive to signals which vary in amplitude, it is readily seen that the reduction or elimination of man-made interference, such as that coming from electrical apparatus and automobile ignition systems is brought about. Of course one would also expect a reduction in natural static.

New All-Wave Tuning Coupler

(Continued from page 152)

posts of your receiver. The terminal wires from the coupler are all labeled and even a child can follow them.

Three taps are provided on the coupler switch, so that you can try the different taps for different wave bands; for most short-waves, up to 50 meters, the third tap is recommended for quiet reception. For reception on the broadcast band, 200 to 550 meters, best results are obtained by using tap number 2, which converts the antenna to a "T" type and brings in distant stations with greater volume; for quiet reception when the signal level is high, tap number 1 is used.

Using a coupler of this type with a doublet, the major part, if not all, of the man-made static is eliminated.

Please mention SHORT WAVE CRAFT when writing advertisers



Today's Most Distinguished Radio Achievement!

CUSTOM BUILT IMPERIAL 18-TUBE Radio

THIS super radio musical instrument was engineered by master craftsmen for those discriminating and exacting radio enthusiasts, who want a finer, more beautiful, more precisely built radio. The Imperial 18-tube All-Wave receiver crystallizes all that is fine and new in today's most advanced conception of radio. Scores of new features, many of them exclusive, result in brilliant sparkling performance heretofore unattainable.

This exclusive instrument will bring in more stations, over greater distances with Higher Fidelity than any other receiver. It is fully guaranteed for years of service—for foreign reception—for your satisfaction. The FREE Trial offer enables you to try this super instrument in your own home, for 30 days, without obligation. Write or mail coupon.



IMPERIAL

Imperial Radio Crafters
Division Midwest Radio Corp.
Dept. 256-A, CINCINNATI, OHIO

Without obligation, send me literature describing the Imperial 18-tube radio . . . and details of your 30-day FREE Trial Plan.

Name _____
Street _____
Town _____ State _____

WHEN CHOOSING A RADIO SCHOOL

RCA Institutes, with its reputation established by 26 years service, is an institution recognized as an important factor in the radio industry. Whether elementary radio principles or advanced subjects, sound applications or practical radio engineering, RCA Institutes is prepared to give you the instruction you need.

RESIDENT SCHOOLS NEW YORK AND CHICAGO with modern standard equipment
EXTENSION COURSES FOR HOME STUDY under convenient "no obligations" plan
Illustrated Catalog on Request.

R. C. A. INSTITUTES, Inc. Dept. SW-35
75 Varick St., New York—1154 Merchandise Mart, Chicago

A Practical Mobile Station

(Continued from page 155)

ALL RECORDS SMASHED!
with the **PROFESSIONAL DX5AC**
Communications hand-spread
receiver designed for the new
METAL TUBES!



- CONTINUOUS BAND-SPREAD ON ALL BANDS!
- Excellent for CW!
- Earphone outlet!
- 12,500 mile range!
- Low-loss ribbed plug-in coils!
- Built-in coil rack!
- High ratio Aero-plane dial!
- Using the new METAL TYPE TUBES, one type 6A8 DUAL tube, one type 6C5, one type 6F6 power pentode and one type 5Y3.
- Dynamic speaker!
- Immediate shipment. Order yours now!

COMPLETE KIT: includes everything needed with dynamic speaker, and four coils to cover from 12-210 meters, your price **\$14.95**

Cabinet—your price \$3.50
Set of 2 Broadcast coils..... \$1.10
READY TO PLUG-IN: custom built laboratory tested receiver, all-wave, 12-550 Meters. Built-in Dynamic speaker and Aretopus tubes. NOTHING ELSE TO BUY! Your price **\$23.90**

FOR THIS MONTH ONLY!
WORLD TROTTER RADIO LABS.
168 Washington Street, Div. C10, New York, N.Y.

Make Your Own Recordings
with the **NEW LOW-PRICED**
S. W. RECORDER

Prove to your friends that you actually received that "hard-to-get" foreign station. Make a professional and permanent recording of any desired short wave or broadcast program. Ideal for all home recording requirements. Operates with any short-wave, broadcast or all-wave receiver. Handles aluminum, celluloid or other metallic and non-metallic records.



Produces clear, crisp and well defined records with a richness of tone never before achieved in any recorder selling for ten times its price.

Send for complete details and Series of Program Recording Bulletins with low net prices.

Free
COLUMBIA SOUND CO. INC.
137 Liberty Street New York, N. Y.

and built a feeder to retain the many advantages of a low impedance line, but to reduce insulation and radiation losses.

The feeder was constructed by threading a No. 14 enameled copper wire with isolantite beads and pulling this bead-strung wire inside of the required length of 3/8" copper tubing. This feeder is mounted on stand-off insulators and may be any length if the antenna is fed in the center. If the antenna is to be fed in Zepp fashion (one end), the feeder must be an odd multiple of 4 feet, i.e., 4 feet or 4 feet x 3, 5, 7, 9, etc. This type of feeder is very efficient for fixed locations, also mobile use.

The above-described station has held perfect and near perfect communication under conditions that heretofore had been considered impossible. In one case a perfect voice conversation for over an hour was held with a station located some thirty miles away, in a parallel valley separated from us by a 1500-foot mountain range!

Our signals receive consistent R-9 reports up to 75 miles distance, and should we drive to a higher elevation, I am confident that we will have no difficulty in holding 2-way communication with 56-60 M.C. static several hundred miles away!

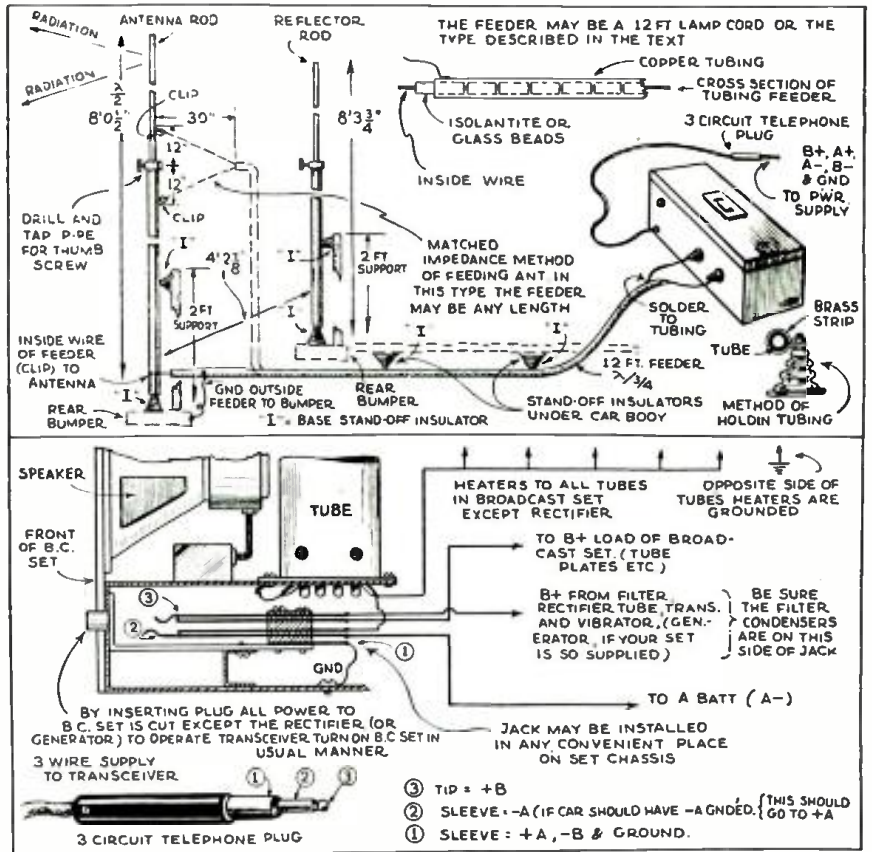

Details of feeder system and method of mounting jack on set.

Here is a real sensation!
A large and good looking
SPORTS BINOCULAR

A real high-power field glass that enables you to enjoy such sporting events as—Horse racing, Baseball, Prize Fights, Football games; can be used on Auto Trips, Beaches, Outings, etc. It's a real buy at a fraction of its real value.



PARCEL POST PREPAID **\$1.50**

5 1/4" long, extended to 6 1/2". Lenses nearly two inches in diameter. Black crackle finish. Carrying strap.

Supply limited—ORDER NOW!
Money back guarantee. You can't lose!

GOLD SHIELD PRODUCTS CORP.
17 West 60th St. Dept. S. New York City

\$20.00 Prize Monthly for Best Set Using 1 or More Tubes

● THE Editors are looking for some "brand-new" Receiving Circuits USING BUT ONE TUBE. The tube must be a standard one and any type tube can be used. The new multi-element tubes provide Short-Wave "Fans" with almost limitless opportunities. Send along your set—or a circuit diagram and 200 word description for opinion as to acceptability.

The Editors offer a \$20.00 monthly prize for the best short-wave receiver submitted. If your set does not receive the monthly prize the Editors will pay space rates for any articles accepted and published.

You had better write the "S-W Contest Editor," giving him a short description of the set and diagram. BEFORE SHIPPING THE ACTUAL SET, as it will save time and expense all around. A \$20.00 prize will be paid each month for an article describing the best short-wave receiver, converter, or adapter. Set

should not have more than five tubes and tube sets featuring one of the new "tw element" tubes are in great demand. Let's see "YOUR" idea of an Ultra-Modern 1-Tube Set!

Sets must be sent PREPAID and should be CAREFULLY PACKED in a WOODEN box! The closing date for each contest is sixty days preceding date of issue (July 1 for the September issue, etc.). In the event of a "tie" an equal prize will be paid to each contestant so tying.

The judges will be the Editors of SHORT WAVE CRAFT, and Clifford E. Denton, who will also serve on the examining board. Their findings will be final.

Address your entries to:
Editor,
SHORT WAVE CRAFT,
98 Park Place,
New York City.

Please mention SHORT WAVE CRAFT when writing advertisers

Human Ills Cured by Short Waves

(Continued from page 135)

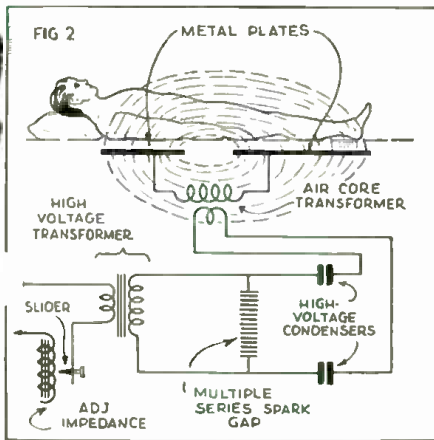

This diagram shows one of the newest inventions in short-wave "fever" apparatus—the Lepel (American) or German (Sanitas) "spark-gap" type oscillator, which employs no vacuum tubes whatever. This type of apparatus has been designed and built to work on frequencies as high as 50 megacycles or 6 meters. It is similar to the well-known Tesla coil hook-up, the secondary being composed of but a few turns of heavy wire or cable with a consequent strong current.

safety and is not employed necessarily for electrical safety.

Fig. 2 of the accompanying group of photos shows Dr. W. R. Whitney, well-known research engineer of the famous General Electric Co., laboratories, demonstrating the use of the new coiled insulated cable placed against the shoulder for the treatment of bursitis, a very painful type of shoulder lameness. Dr. Whitney described bursitis as being similar to the effect of putting sand in the human bearings. A bursa is a small closed sac and we find many of them in the human body.

Some of these, under abnormal health conditions, disclosed to X-rays certain calcareous deposits.

One of the most painful ailments is caused by lime deposits in the large bursa which lies in the shoulder; until recently, it was considered the best practice to remove such deposits surgically in order to free the patient of the stiff shoulder.

Dr. Whitney found that internal heat produced in the shoulder by the high-frequency oscillator employing two thyratron tubes gave excellent results. These tubes were arranged to oscillate at about 24.99 meters or 12 megacycles and yielding about 160 watts. In one case of bursitis, the pain subsided considerably after a half-hour's treatment by this method. After three treatments of one hour each, 90 per cent of the calcareous deposit had disappeared, but other treatments were administered during the month. X-ray pictures taken before, during, and after the treatments, showed the calcareous deposit spreading out and disappearing. Another remarkable case treated by Dr. Whitney in the laboratory was a chronic bursitis of ten years' standing and X-rays showed a dense calcareous deposit. At the end of a month's treatment, the patient was using the afflicted arm in driving a car and, after another month, only a trace of the deposit was visible.

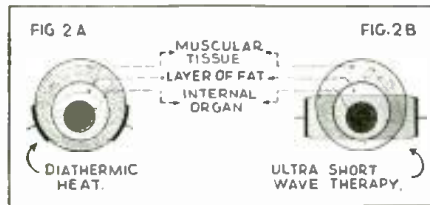

Diagram above shows how high-frequency or short-wave field induces heat in some deep-seated organ within the body, such as the liver, without causing the outer layers of muscle and fat to become heated simultaneously.

cibels, the nature of which may be visualized by writing 10 and adding 200 zeros.

Radio and Wire Carry Voice Around World

(Continued from page 135)

ford's voice at a quarter of a second after 9:30 a.m.

Following his informal conversation with Mr. Miller, Mr. Gifford called the roll of the various points through which the circuit passed, speaking in turn with the telephone engineers at San Francisco, Java, Amsterdam, and London.

In their course around the globe these impulses are repeatedly amplified. The voice of the first speaker, for example, is amplified just as it leaves his telephone on its way out of the building. At some fifty "repeater" stations on the way to the Coast it is similarly boosted to its original volume by vacuum tubes.

Each of these amplifications so far has been rather moderate—seldom more than a thousandfold. The real "shot in the arm" comes at the radio stations. At Dixon, the banks of powerful vacuum tubes that bridge the Pacific magnify the voice impulses millions of times while at the receiving stations in Java the impulses, almost infinitesimally faint after their long journey, are amplified enormously—a billion times or more. This dual amplification is repeated twice, at either end of the Java-Amsterdam and the London-New York radio circuits. In addition, they receive moderate stimulation at periodic intervals on their way from Amsterdam to London.

Thus at the conclusion of their journey the impulses have been magnified by an amount which can be more readily computed than expressed in a form that is easy to grasp. Technically, each voice has received an amplification of about 2,000 de-

The HG-35 All-Wave Set

(Continued from page 152)

in that range of screen-grid voltages where the sensitivity is a maximum. Variation of the detector screen-grid voltage results in a very smooth regeneration control and extremely quiet reception.

The output of the detector is resistance-capacity coupled into a 56 functioning as first audio amplifier stage. For the benefit of those who wish to use headphones there is included a phone jack in the plate circuit of this tube. Insertion of the phone plug automatically disconnects the dynamic speaker. The output of the 56 is fed into a type 2A5 power pentode tube. When properly excited, this tube is capable of delivering 3 watts of audio power to the dynamic speaker.

The speaker field used in conjunction with a pair of 8 mf. filter condensers reduces the A.C. hum to a negligible value. Bias for the power amplifier is obtained by means of a tap on the field coil.

In a single evening, while on test, this model brought in with good loudspeaker volume the following stations: SUZ of Cairo, Egypt; GSA, GSB, GSC of Daventry, England; DJA, DJD, of Zeesen, Germany; EAQ of Madrid, Spain; YV3BC of Caracas, Venezuela; COC of Havana, Cuba. Amateur phone and CW stations are reproduced with terrific volume.

The metal chassis and cabinet are both finished in beautiful black shivel lacquer of a type which will not wear off.



INCREASE YOUR LOG!

NOISE WON'T BOTHER YOU in your S.W. Listening Post if you own a Browning 35, for this amazing all-wave receiver is exceptionally sensitive to signals to which it is tuned but at the same time it is able to disregard utterly any interference and static on adjacent channels. The Listening Post Observer who appreciates the importance of high signal to noise ratio will find the Browning 35 with the TOBE Super-tuner a positive revelation!

No wonder it has been hailed and acclaimed editorially by Radio News, Short Wave Craft, Radio, N.Y. Sun, Radio Index and many others! Words fail to describe the quiet operation, the extreme sensitivity and the amazing ability of this receiver to aid you in identifying new stations and getting their calls.

Your favorite jobber can supply you—if not, write direct to us for

FREE Illustrated tabloid with circuit diagrams, parts list, full details and discounts.

TOBE DEUTSCHMANN CORP.
Dept. G-13, Canton, Massachusetts
Export Dept.: 105 Hudson St., New York



NEW! AND WE HAVE IT. THE TALK OF THE SHORT WAVE WORLD BUILD IT YOURSELF

Browning 35 WITH TOBE TUNER

WRITE FOR FREE CATALOG

M & H Sporting Goods Co.
512 Market St., Phila.

Help to tune in hard-to-get Foreign programs. Specify and insist on

CANNONBALL HEADSETS

Our phones are built with heavy bar magnets which greatly increase their efficiency.

The "popular" set with the "hams."

Write for illustrated circular S-7

C. F. CANNON COMPANY
SPRINGWATER, N.Y.

PATENTS — TRADE MARKS

All inventions submitted held confidential and given personal attention by members of the firm.

Form "Evidence of Conception" and instructions

"How to Establish Your Rights"—Free

LANCASTER, ALLWINE & ROMMEL,
PATENT LAW OFFICES
475 Bowen Bldg. Washington, D. C.

Please mention SHORT WAVE CRAFT when writing advertisers

NEW! Just Out—

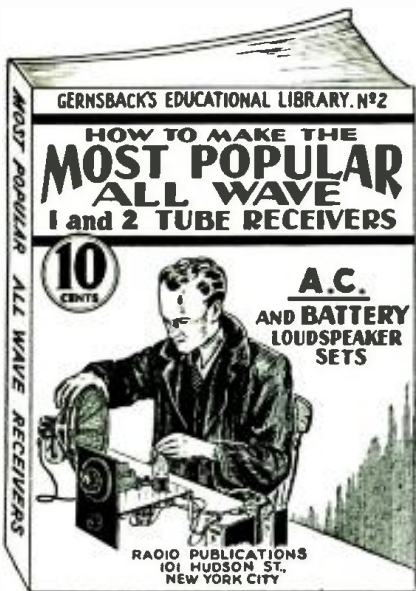

- ★ THERE has been a continuous demand right along for a low-priced book for the radio experimenter, radio fan, radio Service Man, etc., who wishes to build 1- and 2-tube all-wave sets powerful enough to operate a loud-speaker. Sets of this type are always intensely popular with all classes of people who not only wish to amuse themselves to see how good a set they can build with a single or two tubes, but frequently such sets are important for special purposes, particularly where a good little set is required and where space is at a premium. For the thousands of readers who wish to build such sets, this book has been especially published.
- ★ **HOW TO MAKE THE MOST POPULAR ALL-WAVE 1 and 2-TUBE RECEIVERS**
- ★ This book contains a number of excellent sets some of which have appeared in past issues of RADIO-CRAFT, and have been highly successful. These sets are not toys but have been carefully engineered. They are not experiments. To mention only a few of the sets the following will give you an idea.
- ★ The Megadyne 1-Tube Pentode Loud-speaker Set, by Hugo Gernsback. • Electrifying The Megadyne. • How To Make a 1-Tube Loud-speaker Set, by W. P. Cheney. • How To Make a Simple 1-Tube All-Wave Electric Set, by W. Green. • How To Build A Four-In-Two All-Wave Electric Set, by J. T. Bernstey, and others. Not only are all of these sets described in this book, but it contains all of the illustrations, hookups, etc.—the book, in fact, contains everything. Nothing at all has been left out. A wealth of important detail is presented in this book that will make you wonder how we can do it at the price.
- ★ And believe it or not, the book contains over 15,000 words of new legitimate type. The book is thoroughly modern and up-to-date. It isn't just a reprint of what was printed before. All the latest improvements have been incorporated into the sets.
- ★ Remember that this book sells at the extraordinary low price of ten cents; you can not possibly go wrong in buying it. Despite its low cost, our usual guarantee goes with this book as well!
- ★ IF YOU DO NOT THINK THAT THIS BOOK IS WORTH THE MONEY ASKED FOR IT, RETURN IT WITHIN TWENTY-FOUR HOURS AND YOUR MONEY WILL BE INSTANTLY REFUNDED.



There has never been such a wealth of data published in a low-priced radio book of this type in the history of the radio publishing business.

Take advantage of the special offer we are making and use the coupon below.

RADIO PUBLICATIONS
101 Hudson Street
New York, N. Y.

RADIO PUBLICATIONS SW-7-35
101 Hudson Street
New York, N. Y.

Please send immediately your book "HOW TO MAKE THE MOST POPULAR ALL-WAVE 1- AND 2-TUBE RECEIVERS," for which I enclose 10c (coin or U. S. stamps acceptable). Book is to be sent prepaid to me.

Name

Address

City State

Short Wave Scout News

(Continued from page 164)

was received as a confirmation for GSL. HJ4ABL, Ecos de Occidente, Manizales, Colombia, now sends out QSL cards, on which are printed large red call letters. The address is: P.O. Box 50, Manizales, Colombia.

Scout Report for April from A. Centanino, Freeport, Pa.

● RECEPTION was very irregular during the month of April; the static is getting pretty bad on 49 meters.

All the G.S. (England) stations were heard with GSG on 16 meters being good for this time of the year. GSL on 49.10 meters is very good; it operates on Saturday, Sunday, Tuesday, and Thursday at 10-11 p.m., E.S.T.

English phones heard were GAS on 16.38 calling N.Y. everyday at 2 p.m., GBV on 24.41, GCW on 30.64, and GCB on 32.33 meters.

(Germany)—DJA, DJB, DJC, DJD, DJN were heard, DJE on 16.89 heard at irregular times at 8 to 11:30 a.m. E.S.T.

(France)—"Radio Coloniale" is very good on 25.20 meters till "sign off," at 5 p.m., E.S.T., which will be 6 p.m. Daylight Time.

"Radio Coloniale" is very good on 25.63 until the first "sign-off" at 9 p.m.

"Radio Coloniale" on 19 meters is heard fair.

(Italy)—I2RO seems to be settled on the 31.13 meter wave for the afternoon broadcasts; they operate as follows:

31.13 meters—2:30 to 5 p.m. daily—Non-directional antenna.

25.4 meters—9:15 to 10:15 a.m. daily—Directional antenna for the Orient.

49.3 meters 6 to 7:30 p.m. Monday, Wednesday, Friday—Directional antenna to U.S. "The American Hour."

31.13 meters—7:45 to 9:15 p.m.—Mondays, Wednesdays, and Fridays—Directional antenna to South America.

I2RO has also been testing on 31.13 meters Tuesday, Thursday, Saturday, the time is 6 to 7 p.m. and the "American Hour" may change to this wave.

IRM on 30 meters and IRW on 15 meters of "Italo Radio" are heard Sundays irregularly. HVJ, Vatican City on 19 meters is on daily at 10:30 a.m., also on Saturdays at 10 a.m.

(Spain)—EAQ has been very good the past month. Schedule—5:15 p.m., 7:30 p.m. daily, on Saturdays 12 noon to 2 p.m.

(Holland)—PHI is to move to 16.88 meters on Apr. 28. PCJ on 19 meters has been heard nearly every day but Tuesdays; their card said they are on Sunday only.

(Moscow, U.S.S.R.)—RNE, 25.00 meters was heard at irregular times. RKI, 19.94 meters tested with New York and South America several times.

(Cuba)—In Cuba COH was off the air for two days for improvements on their transmitter and antenna, etc. COC on 50 meters is heard daily.

(South America, West Indies and Central America)—The stations in the above countries heard were PRF5, HJ3ABD, HJ4ABB, TIEP, HC2RL, PRADO, HJ1ABB, YV4RC, HJ2ABA, YV3RC, YV2RC, HIX, YV5RMO, HCJB.

HI1A on 48.50 meters has been operating at 5 p.m.

HI4D on 45.50 meters is being heard very well.

HJ4ABA in Colombia is a new station on 25.65 meters; it is heard nearly every night just above "Radio Coloniale."

(United States and Canada)—All U.S. and Canadian stations heard at some time during April; the only change was W1XAZ on 31.35 meters, changing the call letters to W1XK.—Angelo Centanino, Box 516, Freeport, Pa.

Frank Hogler, Brooklyn, N.Y., Reports

● THE following is my report on Short Waves for the past month.

Reception on the short waves for the past month—fair.

Please mention SHORT WAVE CRAFT when writing advertisers

AT LAST

To fill your insistent demand

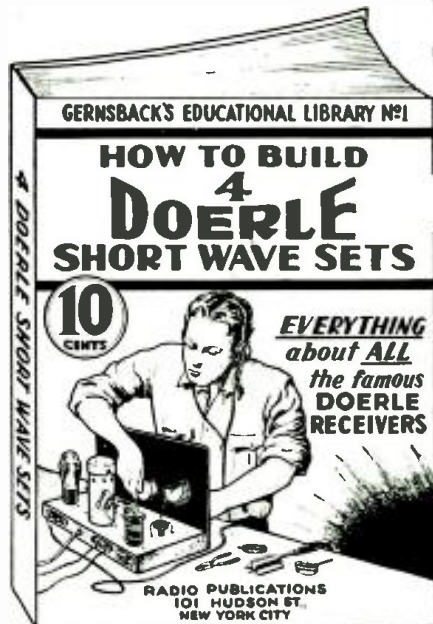

LITERALLY thousands of readers have built the now famous DOERLE Short Wave Radio Receivers. So insistent has been the demand for these receivers that all available literature, including back numbers of SHORT WAVE CRAFT, have long been exhausted.

For the thousands of readers who wish to build any, or all of the many approved DOERLE Short Wave sets, this book has been specially created.

HOW TO MAKE FOUR DOERLE SHORT WAVE SETS

Contains EVERYTHING that has ever been printed on these famous receivers. Four of the most popular sets are described herein. These are the famous sets that appeared in the following issues of SHORT WAVE CRAFT: "A 2-Tube Receiver that Reaches the 12,500 Mile Mark," by Walter C. Doerle (Dec., 1931-Jan., 1932). "A 3-Tube 'Signal Gripper,'" by Walter C. Doerle (November 1932). "Doerle '2-Tube' Adapted to A. C. Operation," (July 1933). "The Doerle 3-Tube 'Signal-Gripper' Electrified," (August 1933) and "The Doerle Goes 'Band-Spread,'" (May, 1934).

Due to a special arrangement with SHORT WAVE CRAFT, we now present a complete as well as compact 32-page book with stiff covers, printed on an extra heavy grade of paper, with numerous illustrations. Nothing has been left out. Not only are all the DOERLE sets in this book, but an excellent power pack if you wish to electrify any of the DOERLE sets, is also described. A wealth of detail is presented in this book despite its ridiculously low price—and, believe it or not, it contains over 15,000 words of legible new type. Everything has been brought up to date; it isn't merely a reprint of what was printed originally, but any improvements on the original sets that were made by readers and various laboratories have been incorporated in this most up-to-date book.

And at the extraordinary price of 10c you cannot possibly go wrong. Despite its low cost, our usual guarantee goes with this book as well.

IF YOU DO NOT THINK THAT THIS BOOK IS WORTH THE MONEY ASKED FOR IT, RETURN IT WITHIN TWENTY-FOUR HOURS AND YOUR MONEY WILL BE INSTANTLY REFUNDED.



There has never been such a wealth of data published in a low-priced radio book of this type in the history of the radio publishing business.

Take advantage of the special offer we are making and use the coupon below.

RADIO PUBLICATIONS
101 Hudson Street
New York, N. Y.

RADIO PUBLICATIONS SW-7-35
101 Hudson Street
New York, N. Y.

Please send immediately your book HOW TO MAKE FOUR DOERLE SHORT WAVE SETS, for which I enclose 10c (coin or U. S. stamps acceptable). Book is to be sent prepaid to me.

Name

Address

City State

Short Waves and Long Raves

(Continued from page 147)

(Thanks very much for your communication, A.E.L., and we are very pleased to know that the Navy Department likes SHORT WAVE CRAFT and that you have found some of our articles on antennas and eliminators of service. While your station certainly has a remarkable array of short-wave transmitters, covering a frequency range as high as 26,000 kilocycles, you will probably be interested to know that the editors have in operation in their laboratory transmitters operating on 120,000 kilocycles or 2.5 meters, employing the SHORT WAVE CRAFT "long lines" oscillator, consistent communication having been carried on over distance of 40 miles and more. [This 2.5 meter transmitter was described in the November issue.] We hope to hear from you again and also other representatives of U.S. Naval Stations.—Editor)

Modified Doerle Rolls 'Em In!

(Continued from page 147)

(Thanks for the excellent photo, Robert, and we hope to receive many similar photos from our short-wave fans. We receive a great many photographs of short-wave stations but somehow or other, many of them appear to be so "dead" that the editors are hard pressed to choose those which they believe will be of interest to the readers of this magazine each month.—Editor)

THE "PEE-WEE 2-TUBER" STEPS OUT!

Editor, SHORT WAVE CRAFT:

I have just completed the "Pee-Wee 2-Tuber" and boy, does it work swell! I have already heard several foreigners, although the set has only been in operation a short time. I have read SHORT WAVE CRAFT for a long time and built several of the simpler sets, but the "Pee-Wee 2-Tuber" is the best yet.

While I'm writing I wish to announce the opening of a new short-wave club—"The B-C Radio Amateurs." This club meets once a week at the members' homes and is desirous of getting new members. Everyone is welcome whether a licensed amateur or just a short-wave listener. For inquiries of how to join, address the secretary at the below address. The club has one station on the air already and some of the members intend getting their "tickets" in the near future. SHORT WAVE CRAFT is the club's magazine and we all enjoy reading it.

A Practical Short-Wave Program Recorder

By Charles R. Shaw*

● TO meet every type of recording equipment, the Columbia Sound Co., has developed a series of five different short-wave program recorders, ranging in operating type from simple recording with an ordinary short-wave receiver, to elaborate "dubbing" of one or more programs onto one record with mixing and fading facilities for announcements. Suitable playback equipment is also provided. The simplest equipment is essentially composed of a recording phono-motor, a combination recorder and playback unit, and a set of adapters for connection to any standard or special custom-built short-wave receiver. The entire recorder is housed in a compact portable leather-covered case which may be locked up and safely stored when not in use.

By providing suitable adapters for the detector and amplifier tubes together with a special switching arrangement, it becomes a relatively simple matter to record

I will be very glad to receive letters from other Hams and S-W fans and promise to answer all of them.

CHARLES C. ERHARDT, W2HNJ,
1235 Madison St.,
Brooklyn, N.Y.

(More Power to the "B-C Radio Amateurs Club," and we hope that it grows to be a right lusty child. We are happy indeed to know that you have had such swell results with the "Pee-Wee 2-tuber" and we have had many laudatory letters concerning the "Pee-Wee."—Editor)

GETS EUROPE O.K. ON "POCKET SET"

Editor, SHORT WAVE CRAFT:

I'm writing this letter to tell you what a swell "mag" I think you have. I've only taken it for a few months, but I'm sold on it "and how." I wouldn't miss a copy now for "fun, money or marbles."

I also wish to inform you of the splendid results I've had with the "1-tube pocket set" described in the December, 1934, issue of SHORT WAVE CRAFT. "Believe it or not" the following are the stations I've received on the 49-meter band alone, since I built the set in January:

W1XAL—Boston, Mass.
W2XE—New York City.
W3XAL—Bound Brook, N.J.
W8XK—Pittsburgh, Pa.
W8XAL—Cincinnati, Ohio.
W9XF—Chicago, Ill.
W9XAA—Chicago, Ill.
PRADO—Riobamba, Ecuador.
COC—Havana, Cuba.
YV6RV—Valencia, Venezuela.
GSA—London, England.
GSL—London, England.
DJC—Berlin, Germany.
VE9GW—Rowmanville, Ont.
VE9CL—Winnipeg, Man.

I've received verifications from: W1XAL; W3XAL; W8XK; W8XAL; W9XF; W9XAA; VE9CL, and last but by far not the least, YV6RV.

Yours for continued success,

DONALD F. AYERS,
West Bloomfield, N.Y.

(The "1-Tube Pocket Set" described in the December, 1934 issue seems to be going Great Guns! We have received hundreds of letters concerning the remarkable performance of the "1-Tube Pocket Set" and the strange part of it is that many of the stations, even those several thousand miles away, have frequently been picked up on the loudspeaker with this little 1-tube set.—Editor)

RADIO OPERATING for home study

New book prepares you to pass examinations for all classes of radio operator licenses. Will help experienced operator or station technician to advance to better job. Equally suited for man just entering this field. Planned especially for home study.



Just published

PRACTICAL RADIO COMMUNICATION

By Nilson and Hornung, well-known radio experts, instructors, writers. Covers radio principles, radio equipment and power apparatus as applied to broadcasting, marine, police, aeronautical and amateur radio. Includes entire spectrum of radio wave lengths, from ultra-short to long-wave. Chapters on tubes, circuits, control-room operation, transmitters, radio aids to navigation, etc. Complete, practical, authoritative. New features of arrangement, 744 pages, nearly 500 illustrations, \$5.00. Use this book to get ahead in radio operating.

Examine book on approval; send this coupon

McGraw-Hill Book Co., Inc.,
330 W. 42nd St., N. Y. C.

Send me Nilson and Hornung's Practical Radio Communication for 10 days' examination on approval. In 10 days I will send \$5.00, plus few cents postage, or return book postpaid. (Postage paid on order, accompanied by remittance.)

Name
Address
City and State
Position
Company SWC-7-35
(books sent on approval in U. S. and Canada only.)

IMPROVED POSTAL '35



Now over 50 important features including the New Postal improved Drawer Type Coils, Built-in Short Wave Booster, Continuous Band Spread, Audio Beat Oscillator, A.V.C., Manual Control, and many other important short wave features.

Write Immediately for Details and Special Price on the New and Improved Postal '35

POSTAL RADIO
135-11 LIBERTY ST. NEW YORK, N.Y.

CABINETS

for ALL STAR SR. & JR.



with hinge cover finished to match the ALL STAR SET.

Our Low Price

\$3.95

We do not supply panel, dial or knobs ANY MAKE RECEIVER. Send drawing, blue print or give complete description for estimate.

Dealers and Jobbers: Write for special prices.
KORROL MFG. CO., Inc. Dept. S-7
232 GREENWICH ST. NEW YORK CITY

*Design Engineer, Columbia Sound Co.

Please mention SHORT WAVE CRAFT when writing advertisers

DO YOU WANT TO OBTAIN AC ELECTRICAL POWER

from a Windmill, from available Waterpower, from your Automobile, from your Motorcycle, from your Bicycle, Footpedals or Handcrank (for transportable Radio Transmitters, Strong Floodlights, Advertising Signs); do you want to operate AC Radio sets from 32 V.D.C. farm light systems; operate two generators in series to get 200 V.A.C; obtain two phase and three phase A.C., etc., etc.

GET OUR WESTINGHOUSE



200-WATT
110 V. A.C.
Power Generator
MANUFACTURED FOR U. S. SIGN. CORPS

SPECIFICATIONS:

HOUSING—Aluminum (Diameter 6 1/4 in. Length—5 1/4 in.). SHAFT—2 3/16 in. (driving end). Diameter 9/16 in. (the end is threaded for a distance of 1/4 in.). BASE—Cast Iron (Length—7 1/2 in. Height 1 9/16 in. Width 4 1/2 in.). OUTPUT—200 Watt 110 volts AC (speed 4500 R.P.M.). STATORS—Two pairs (two North and two South). ROTOR—12 tooth inductor. Built-in commutator. Rotor turns in ballbearings.
3/4 to 1/2 H.P. needed to run Generator.

FREE With each Generator we supply a set of diagram-blue prints and instructions showing twenty-five different uses, technical information, electrical hook-ups and installing explanations. We also include a set of four replacement carbon brushes.

There Are Over 25 Applications Some of which are:

A.C. Dynamo lighting from eight to ten 20 Watt 110 Volt lamps. Short Wave transmitter supplying 110 volts AC for operating "Ham" transmitter. Operating 110 v. AC 60 Cycle Radio Receiver in DC districts. Motor Generator. Public Address Systems. Electric Sirens on motor boats, yachts, etc. Camp Lighting. Short Wave artificial "ferret" apparatus. Television. Pelton Waterwheel for lighting or other purposes. Airplane: for lighting strong search lights or electric signs. Laboratory Work. Generator, as described, including four replacement carbon brushes. Blue-Print and instructions \$7.90

Shipping weight 16 lbs.

(Replacement carbon brushes bought separate \$1.50 per set of four. Set of instructions bought separate \$1.00.)

Electrical Portable SPRAYER OUTFIT

\$27⁵⁰
COMPLETE

Formerly sold for \$68.50

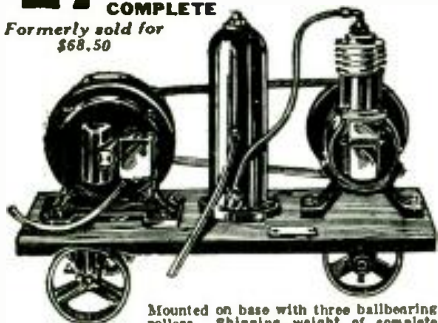

Mounted on base with three ballbearing rollers. Shipping weight of complete outfit, 55 lbs.

This is the ideal outfit for all-around spraying work wherever current is available. With it you can spray paint, varnish, dyes, enamel, lacquer, insecticides, etc., with speed. You can move it from one room to another. Simply insert plug into electric socket and this marvelous machine is ready.

Outfit equipped complete with Internal Mix Spray Gun, with quart aluminum cup, which enables you to obtain round or fan spray, 1/4-h.p. heavy duty motor, 110-volt, 60 cycles, A.C., and air filter Redox Air-Cooled Compressor, 1 1/2 x 1 1/2, 15 feet of hose, cord and plug.

Price of complete outfit with gun, \$27.50
Price of outfit without motor, \$20.00
Price of Internal Mix Spray Gun, \$7.50 alone
Price of Filter Tank, \$4.25 alone
(Complete with Gauge and 60 lbs. Safety Valve)
Price of Compressor, \$7.50 alone

WELLWORTH TRADING CO. 8W-7-35
560 W. Washington Blvd., Chicago, Ill.
Enclosed you will find my remittance of \$..... for which please send me

Name
Address
City State

sirable if the amplifier portion of the radio set and its speaker are not designed for high-fidelity reproduction, or are incapable of developing sufficient power (3 to 8 watts) for suitable recording on ungrooved aluminum discs. The amplifier easily develops 10 watts of undistorted audio power with less than 2 percent harmonic content, and provides a uniform frequency response between 40 and 10,000 cycles. Its circuit design includes a special set of high and low frequency attenuators for minimizing surface scratch and for adjusting the playback performance of the system to the acoustic conditions of the room in which it is used.

A still more elaborate outfit includes a double-button carbon microphone for local announcements, and a two-position mixer-fader control panel for mixing any two signals, or fading from one into another, or using one as the background for the other.



Complete Short-Wave Program Recorder, with Recording Cutter Head and Magnetic Pick-up for "playing back."

With this system, a number of valuable and unusual recordings may be made. For instance, it is possible to interpose local announcements (through the microphone) while the short-wave station is being recorded as a "background."

In view of the fact that once a recording is started it must be continued without interruption clear through to the end (if a continuous track is desired), it might sometimes be desirable to combine onto one record the best portions of a number of recordings. This can easily be done by dubbing or re-recording the desirable short sequences of a number of discs, together with local remarks, onto one disc.

The correct procedure to follow is to lightly chalk-mark the outer limits of the recording to be dubbed. These records are arranged in sequence alongside an auxiliary turntable. The playback pickup is connected to the input of the amplifier while the cutting head is connected to the output. The microphone and the announcer who is to give the descriptive talk (which adds considerable educational value to the record) are placed at some distance from the recording outfit—preferably in another room wired with suitable start and stop signal lights.

For an effective presentation the record starts with a short announcement followed by a gradual fade-out of voice and a fade-in of the first portion of the foreign program. As the playback pickup nears the limit of the desired portion of the recording, the announcer is signaled to start talking. The operator, who is monitoring the program with earphones, gradually fades the record out and announcement in. While the announcement is being made, the second record is placed into position and the playback motor started. Once again the announcer is gradually attenuated and signaled to stop after the second recording has been accentuated to the required degree. This procedure is followed until all of the desired programs have been dubbed onto one record. These recordings if properly prepared, will literally represent an "audible trip around the world" on a 12-inch record!

The author will be pleased to answer all questions relative to program recording. Address all inquiries to SHORT-WAVE CRAFT.

DATAPRINTS

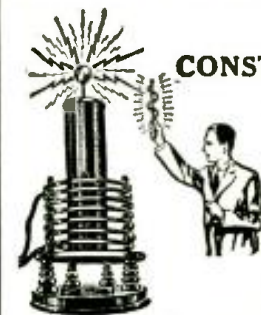

Just the CONSTRUCTION Information You Need To Build Electrical Apparatus

TESLA OR OUDIN COILS
Dataprint containing data for constructing this 3 ft. spark Oudin-Tesla coil. Requires 1 K.W. 20,000 volt transformer as "exciter". See list below. Includes condenser data. \$.75

8 inch spark data for building, including condenser data; requires 1/4 K.W. 15,000 volt transformer; see list below. .50
Violetta type, high frequency coil data; 110 volt A.C. or D.C. type; 1" spark; used for "violet ray" treatments and "Experiments". .50
How to operate Oudin coil from a vacuum tube oscillator. .50
3 inch spark Tesla coil; operates on Ford ignition coil. .50
3 inch spark Oudin coil; 110 volt A.C. "Kick-Coll" .50
20 Tricks with Tesla and Oudin Coils. .50

TRANSFORMER DATA
1 k.w. 20,000-volt transformer data, 110-volt, 60-cycle primary. Suitable for operating 3 ft. Oudin coil. .50
1/4 k.w. 15,000-volt transformer data, 110-volt, 60-cycle primary. Suitable for operating 8-inch Oudin coil. .50
Electric Welding Transf. (2 K.W. 110 Vt. Prim. 18 Vt. Sec. Other Sec. Vt. data given.) .50
Induction Coils—1 to 12 inch spark data. .50
ARTIFICIAL FEVER Apparatus. .75
(Low, Medium & High Power Data Given)



SLIDE RULE
MIDGET
Metal 4" Dia.
Price \$1.50.
Case 50c extra

This rule solves any problem in multiplication, division, addition, subtraction and proportion; it also gives roots and powers of numbers, sines, cosines, tangents and cotangents of all angles; also logs of numbers. Adds and subtracts fractions. Approved by colleges.

10" Dia. 27" Scale "Special" Rule, \$2.75.
Multiplies and Divides, but has no "Trig" Scales.

TELEGRAPHONE — Records Voice or "Code" signals on steel wire by magnetism. Code can be recorded "fast" and translated "slow." Construction data (special) \$0.50

MAGNET COIL DATA
Powerful battery electro-magnet; lifts 40 lbs. \$0.50
110 Volt D.C. magnet to lift 25 lbs. .50
110 Volt D.C., 300 lb., Lift electromagnet. .50
110 Volt D.C. solenoid; lifts 2 lb. through 1 in. .50
110 Volt D.C. solenoid; lifts 6 lb. through 1 in. .50
12 Volt D.C. solenoid, lifts 2 lb. through 1 in. .50
A.C. Solenoid, powerful, 110-volt, 60-cycle. .50
MOTOR—1/16 H.P., 110 volt A.C., 60 cycle (suitable for driving 12" fan, etc.)—Data. .50
60 or 1,200 cycle Synchronous motor Data. .50

MISCELLANEOUS DATAPRINTS
Treasure Locator \$0.50
Electric Refrigerator data .50
20 motor circuits—hook-ups. .50
20 practical telephone hook-ups .50
100 mechanical movements for inventors. .50
Polarized Relay—Ultra Sensitive .50
Electro-medical coil (shocking coil) .50
Water-Wheels—How to Build and Light your house. .50
20 Electric Bell circuits. .50
Public Address System .50
Electric chime ringer; fits any clock. .50

20 "Electrical Tricks" for LODGES and PARTIES \$0.50

How to Fry Eggs on Cake of Ice Electrically. \$0.50
"Rewinding" Small Motor Armatures. .50
"ENGINEERING SERVICE BY MAIL"
Send Sketch of Your Problem for Estimate.
(20% off on orders for \$3.00 or more. No C.O.D.)

The DATAPRINT COMPANY
Look Box 322 RAMSEY, N. J.

Please mention SHORT WAVE CRAFT when writing advertisers